

Owner's manual



POWER LINE 4000

POWER LINE 4000

Please read this manual carefully before use and keep it in a safe place for future reference

Further information on ERGO-FIT-products available at:

ERGO-FIT GmbH & Co. KG

Blocksbergstraße 165

D-66955 Pirmasens

Phone: +49 (6331) 2461-0

Fax.: +49 (6331) 2461-55

E-Mail: info@ergo-fit.de

<http://www.ergo-fit.de>

Development and production of all devices of the MED series according to the European Medical Device Directive 93/42/EWG. They thus show the CE marking and the number of the notified body

CE0297

© 2019 by ERGO-FIT GmbH & Co. KG. All rights reserved.

This owner's manual has been created with great care. Please inform us of any detail that does not correspond to your training tool to allow for the quickest possible remedy of any possible discrepancy.

This document is protected by copyright. All rights originating from this, particularly the right of copying, duplication, distribution as well as translation and reprint, even copies in extract, are reserved. No part of this manual may be reproduced, manifold or distributed for any kind of purposes or in any kind of form, by any means, (print, photocopy, microfilm, or any other information-saving mechanisms) without prior written permission given by the company ERGOFIT GmbH & Co. KG.

Trademark:

ERGO-FIT and the ERGO-FIT Logo are registered trademarks of ERGO-FIT GmbH & Co. KG. All other trademarks mentioned or shown in the following text are trademarks of the respective owners and are recognised as protected.

Technical and optical modifications as well as misprints reserved.

Version: POWER LINE 4000-20190401-en

Printed in Germany

Dear customer,

We are glad that you have decided to purchase an ERGO-FIT training tool. You are now the owner of a sophisticated and exclusive training system that combines highest technical standards with practice oriented ease of use.

This owner's manual contains information on multiple gym machines. For this reason, you will find explanations that do not apply to your training machine.

You will find important information on the operation and use of your training machine in this owner's manual. We recommend that you read this owner's manual carefully before training in order to become familiar with your training device quickly and to understand its correct and safe use.

Should you have any questions that are not answered in this manual, please contact us. The ERGO-FIT team is always there for you!

Table of contents

1	General information	1
2	Safety information	5
3	Short manual	11
4	Destination of the product	13
5	Transport and setup	21
6	Setup	43
7	Operation	49
8	Workout	55
9	Maintenance	79
10	Troubleshooting	83
A	Appendix	87

Please note:

This user manual provides information on several devices.
Details may vary depending on your model!

Chapter 1 General information

1.1	ERGO-FIT Cardio Equipment at a Glance	2
1.2	General Information on this Manual	3
1.3	Parts Included in the Delivery	3
1.4	Customer Service	4

Please note:

This user manual provides information on several devices.
Details may vary depending on your model!

1 General information

1.1 ERGO-FIT strength equipment at a glance

ERGO-FIT's POWER LINE 4000 range consists of strength training machines designed for building up all relevant muscle groups. ERGO-FIT strength training machines offer you the best training options, regardless of your age, gender, or fitness level.

Among others, the eccentric technique, integrated beverage holders, and the concentration on functional aspects are highlights of the whole product line. In addition, it is the ease of use and the customisation that demonstrate ERGO-FIT's focus: A high technical standard, optimal training possibilities and precise training control, combined with customer-friendly ease of use.

However, technology alone is not all that is required to develop outstanding training machines. They also need to meet biomechanical and sports medical requirements. Priority is given to the human being. Thus, a sophisticated training and testing system can only be developed by combining technical electronic expertise with the latest advances in sports medicine and coaching science. ERGO-FIT clearly met this target.

Our POWER LINE 4000/4000 S is especially designed for fitness purposes, whereas POWER LINE 4000 MED/4000 S MED is designed to meet medical targets.

The lifetime of the equipment is 6 years.

EN 957-2: 7.2 b) Please note that the exercise machine may only be used in areas where access and supervision are controlled by the owner. The extent of this supervision depends on the users, i.e. degree of reliability, age, experience etc.

Advantages and benefits Regular training on these machines prevents malpositions from day-to-day life, associated arthrosis of the spinal column as well as muscle tension, and will increase personal performance even at an advanced age. Your workout machine represents an indispensable tool in injury prevention and rehabilitation. You will feel fit, more powerful, more attractive, and more balanced.

1.2 General information on this manual

This manual provides you with helpful information, regardless of if you are already familiar or have no experience with ERGO-FIT training machines.

It is structured in a way that you can find the desired information in the table of contents easily and thematically. In addition, a short manual has been produced.

However, if you belong to this user group and wish to read the short manual only, you should review the safety information first.

This manual will give you many hints and tips, which will familiarise you with your workout machine's features and allow you to become an experienced user very quickly.

You should always keep this manual easily accessible. This saves you from unnecessary and time-consuming queries and enables you to rapidly fix any possible error.

1.3 Scope of delivery

Please check if the delivery is complete and inform our sales department immediately of any missing parts (phone: +49 (6331) 2461-25).

Please ensure that the following parts are included in your delivery:

1. The correct model (series) of training machine

Handle and weights not included.

1.4 Service

Our service comprises problem analysis, technical support, spare parts service and information services.

In case of technical questions and service orders, please call us at:

Head office:

Phone: +49 (6331) 2461-0

Fax: +49 (6331) 2461-55

Service and spare parts:

Phone: +49 (6331) 2461-20 international

or: +49 (6331) 2461-45 international

or: +49 (6331) 2461-23 national

or: +49 (6331) 2461-27 national

or: +49 (6331) 2461-29 national

Chapter 2 Safety information

2.1	What you need to know when using your training machine	6
2.2	Instructions for Safe Operation	8
2.3	How to Avoid Electric Shocks	8
2.4	Choosing the right place of installation	8
2.5	What needs to be considered in case of repair	9
2.6	Things to be Avoided	9

Please note:

This owner's manual contains information on multiple gym machines.
There may be variations in detail according to the type of machine!

2 Safety information



Please read the following chapter carefully and respect all safety instructions before you start using your workout equipment. Please keep this manual in a safe place in order to pass it over to future owners if you sell your workout device.

For evidence of ownership, please complete the following form:

Model/series _____
 Serial number _____
 Date of purchase _____

You will need this information in case of warranty.

The following symbols designate important information

	Caution!	This warning draws the attention to hazards that could result in personal injury or death.
	Warning!	This warning draws attention to hazards that could result in property damage.
	Tipp!	This hint contains important information and tips to improve operation.

2.1 What you need to know when using your training machine?

- ⊗ Carefully read this manual prior to using your product.
- ⊗ It's the owner's responsibility to inform the users of all hazard warnings and provide them with operating instructions.
- ⊗ Familiarize yourself with the machine before you start your workout.
- ⊗ For safety reasons inspect the power cord for signs of damage before each use.
- ⊗ Switch off the machine after the workout and disconnect it.
- ⊗ Only use the machine after a proper function test (see chapter 6.3 for more information). For your own safety and before every use, please check the machine for damage (loose screws, worn parts, cords etc). If the machine is damaged, do not use it before it is repaired.
- ⊗ In order to reduce risk of injury please wear appropriate clothes and footwear for exercise.
- ⊗ In case of nausea, dizziness, pain in the chest, limbs or joints, stop workout

immediately and see your trainer or a doctor.

- ⊗ If you wear a cardiac pacemaker or have health problems please consult your doctor before using the machine. Discuss your workout program with him. Only use MANUAL mode.
- ⊗ Do not hold your breath during training, as this causes a reduced blood flow to and from the brain and an increase in blood pressure. When muscle training, it is important to breathe out during strain (i.e. the phase when the weight is lifted) and to breathe in during relaxation (i.e. when the weight is lowered).
- ⊗ Your workout machine is not a toy! Children must be supervised if they are near the equipment. Children cannot always predict possible hazards. Parents or other supervisors should always be aware of their responsibility because the playful and adventurous nature of children may lead to situations that the workout machine is not intended for.
- ⊗ The machine is only to be used on instruction of a physician and / or a supervisor. The machine must not be used without the presence of a supervisor.
- ⊗ Make sure that third parties do not stand close to moving parts
EN 957-2: 7.2 c) If the exercise machine is featured as described in 5.4.1.3.2 (snap-on weights without cover), the user should always be able to see the machine during workout. The user always needs to see the snap-on weights to avoid any danger to others.
- ⊗ If you are lying or sitting on a towel, please make sure that it does not come in contact with spinning or running parts of the machines.
- ⊗ When adjusting the height of the seat, backrest or footrest, please make sure to retighten the fasteners after individual adjustment of the optimal position. Otherwise, there is a risk of injury.
- ⊗ Do not put your hands between the snap-on weights. Otherwise, there is a risk of injury.
- ⊗ Only use the included dowel pins for adjusting the weights. Make sure to insert the dowel pins completely into the borings of the snap-on weights.
- ⊗ Warm up thoroughly before training. Start the training slowly and gradually increase the intensity until you reach the desired strain degree within your range of control.
- ⊗ Never start power training with the maximum strain. Increase its intensity slowly with light weights to get used to the right motion sequence and familiarise your body to the unaccustomed strain. If you set the strain too high in the beginning, you might injure or damage your musculoskeletal system.
- ⊗ Note that physical fatigue reduces coordination and increases the risk of injury.
- ⊗ Please pay attention to the correct use of the triceps rope. Always clasp the rope with both hands. Never hold and tear at only one end of the rope due to risk of injury.
- ⊗ Carefully lower the weights during the workout. They must not be thrown since any impact may damage the weights.
- ⊗ Do not touch the USB port, RS232 port or audio port during the training.

- ⊗ Certain conditions or actions can cause static electrification of electronic devices. Using earphones can result in short minor electrostatic discharge. To reduce the risk of electrostatic discharge when using earphones touch a metal object before connecting the earphones.
- ⊗ Please review the additional safety and operational notices in this manual.

All safety instructions in this manual are based on many years of experience and self-conception.

2.2 Instructions for Safe Operation

- ⊗ After delivery, make sure that the machine has not been damaged during transport. In case of doubt, contact our customer service and do not start the machine.
- ⊗ Always check the power cord for damages before starting the machine.
- ⊗ Switch off the machine after the workout and disconnect it.
- ⊗ Regularly check the cable, wires, steel cable, Kevlar cable and cable clamp for damage.
- ⊗ Do not place beverages on your training machine. Instead, use the bottle holder which is specially designed for beverages.
- ⊗ Set up the training machine so that there is sufficient open space around it. This reduces risks to the trainee as well as other people around.

2.3 How To Avoid Electrical Shocks

- ⊗ Do not use damaged power cords.
- ⊗ Do not unplug by pulling on the cord.
- ⊗ Switch off and unplug the machine before you open it.
- ⊗ If liquid gets inside the machine, unplug the machine immediately and call the customer service.
- ⊗ Do not insert any objects in the ventilation slots. This may cause a short circuit.
- ⊗ Don't run the supply cable under the machine, neither between the mobile parts or devices of the machine. The insulation could be damaged unconsciously.

2.4 Choosing the right place of installation

- ⊗ The machine can be set up on any level and stable floor. Make sure that it stands firmly on the floor.
- ⊗ Never put wood, cardboard or similar materials underneath the machine to compensate surface unevennesses. This increases the risk of an accident.

2.5 What needs to be considered in case of repair

- ⊗ Mechanical and electric parts must be replaced with original equipment only.
- ⊗ Repairs must be carried out by a qualified technician only. If you do not have the necessary qualifications, ask the ERGO-FIT Service Center. Electrical or mechanical modifications or alterations performed by unauthorized personnel may void the warranty.

2.6 Things to be Avoided

- ⊗ Only use the machine for the purposes it was intended for. If you use the ERGO-FIT machine for other than the intended purpose, you will be charged for all damages resulting from this. In this case any warranty is void!
- ⊗ Never use the machine in any other way than for those purposes described in this manual. This may damage the machine and can cause serious health problems.

Refer to the appendix for a list of the most important safety guidelines. Attach this list near the machine where it is clearly visible. All users of the machine must familiarize themselves with the dangers and safety regulations. The manufacturer will not be liable for personal injury or property damage.

Chapter 3 Short manual

Please note:

This owner's manual contains information on multiple gym machines.
There may be variations in detail according to the type of machine!

3 Short manual

After delivery of your power machine, please check first if the serial number (see type label) is identical with the one indicated on the delivery note and if all components listed in chapter 1.3 ("Scope of delivery") are included in the delivery.

Pneumatic spring mechanism: Lift the adjustment lever. The integrated pneumatic spring will automatically lift the seat area or restraint. To lower the seat or the restraint, loosen the adjustment lever and push the seat downwards into the desired position with the help of your body weight. To lock the seat or restraint at the desired height, bring the adjustment lever back to its initial position.

- ⊗ Pneumatic spring mechanism: Pull the adjustment lever upwards. Due to the integrated pneumatic spring, the corresponding seat area or the bracket automatically lifts upwards. If you want to lower the seat area or the bracket, with the adjustment lever raised, press down on your body weight to the desired position. To fix the desired height, move the adjustment lever back to the initial position.



Depending on the user weight the pneumatic spring may bag in about 120 mm. This may affect the reading of the position number. After you have adjusted the seat area or the bracket according to the instructions, stand up in order to avoid that the seat area or the bracket is affected by the user weight. Now read the position number.

- ⊗ Snap-in mechanism: Pull the dowel pin out of the punched matrix. Pull the seat area or restraint up or down. To lock the seat area or restraint at the desired height, let the dowel pin snap-in again.

Note that the seat is a standard seat. This means that every adjustable seat has the same snap-in positions. On some exercise machines, not all snap-in positions may be usable.

Exercise machines with eccentric technique (e.g. LEG EXTENSION 4000) are equipped with adjustable strain levers. Pull out the dowel pin and adjust the strain as desired.

During training make sure to use the following exercise technique: Breathe out during the strain sequence and breathe in during the relaxing sequence. The motions should be carried out slowly. Avoid jerky movements. If you want to stop the workout, control the downward motion of the weights. The exercise is finished only when the training weight is resting.

Chapter 4 Destination of the product

4.1	Back muscles	14
4.1.1	BACK EXTENSION 4000	14
4.1.2	BACK PULL 4000	14
4.1.3	BUTTERFLY REVERSE 4000	14
4.1.4	LAT PULL 4000	14
4.2	Shoulder muscles	15
4.2.1	SHOULDER ABDUCTION 4000	15
4.2.2	SHOULDER PRESS 4000	15
4.3	Chest muscles	15
4.3.1	BUTTERFLY 4000	15
4.3.2	CHEST PRESS 4000	15
4.4	Upper arm muscles	15
4.4.1	BICEPS FLEXION 4000	15
4.4.2	TRICEPS EXTENSION 4000	15
4.5	Abdominal muscles	16
4.5.1	ABDOMINAL FLEXION 4000	16
4.5.2	ABDOMINAL TORSION 4000	16
4.6	Pelvic muscles	16
4.6.1	ABDUCTOR 4000	16
4.6.2	ADDUCTOR 4000	16
4.6.3	HIP EXTENSION 4000	16
4.7	Thigh muscles	16
4.7.1	LEG EXTENSION 4000	16
4.7.2	LEG FLEXION 4000	17
4.7.3	SQUAT PRESS 4000	17
4.8	Multifunctional	17
4.8.1	CABLE 4000	17
4.8.2	CABLE CROSSOVER 4000	17
4.8.3	CABLE TOWER 4000	17
4.8.4	MULTI PRESS 4000	18
4.8.5	PULL UP/DIP 4000	18
4.8.6	SEATED DIP 4000	18
4.9	Benches	18
4.9.1	ABDOMINAL BENCH 4000	18
4.9.2	BACK BENCH 4000	18
4.9.3	FLAT BENCH 4000	18
4.9.4	MULTI BENCH 4000	18
4.9.5	OLYMPIC FLAT BENCH 4000	19
4.9.6	OLYMPIC INCLINE BENCH 4000	19
4.9.7	SCOTT BENCH 4000	19
4.9.8	SQUAT RACK 4000	19

Please note: This owner's manual contains information on multiple gym machines.

There may be variations in detail according to the type of machine!

4 Destination of the product

The machines of this series are stationary exercise machines primarily designed to improve strength abilities in terms of muscle building or strength endurance. They are specially designed for fitness purposes. They are provided for use in training areas of organizations such as sport associations, educational establishments, hotels, sport halls and clubs, where access and control is specifically regulated by the owner (person who has the legal responsibility). The mechanical layout allows for low-impact training as the motion direction is set, withdrawal movements are reduced and muscles are targeted. The machines meet almost all strain demands as each of the weight plates can be snapped in individually. Different models, whose intended purpose is described in the following section, have been designed to tailor training to individual needs.

4.1 Back muscles

4.1.1 BACK EXTENSION 4000

BACK EXTENSION 4000 is a strength training machine that is designed for strengthening the back muscles by erecting the upper body. The training strain is controlled using plug-in weights. Regular workouts on this machine prevent postural deformity and spinal column arthrosis.

4.1.2 BACK PULL 4000

BACK PULL 4000 is a strength training machine that is designed for strengthening the muscles between the shoulder blades through a rowing motion. The training strain is controlled using plug-in weights. The seat height adjustment allows users to set an optimal training position.

4.1.3 BUTTERFLY REVERSE 4000

BUTTERFLY REVERSE 4000 is a strength training machine that is designed for strengthening the muscles which stabilise the neck and the thoracic column by opening the arms acromially. The training strain is controlled using plug-in weights. The seat height adjustment allows users to set an optimal training position. Regular workouts on this machine prevent postural deformity and back pain caused by improper stress.

4.1.4 LAT PULL 4000

LAT PULL 4000 is a strength training machine that is designed for strengthening the back muscles by a pull-down motion of the arms. The training strain is controlled using plug-in weights. The restraint of the thighs makes the workout more effective. The seat height adjustment allows users to set an optimal training position.

4.2 Shoulder muscles

4.2.1 SHOULDER ABDUCTION 4000

SHOULDER ABDUCTION 4000 is a strength training machine that is designed for strengthening the shoulder muscles by abducting the arms. The training strain is controlled using plug-in weights. The seat height adjustment allows users to set an optimal training position.

4.2.2 SHOULDER PRESS 4000

SHOULDER PRESS 4000 is a strength training machine that is designed for strengthening the muscles which stabilise the neck and the thoracic column by stretching the arms upwards. The training strain is controlled using plug-in weights. The seat height adjustment allows users to set an optimal training position.

4.3 Chest muscles

4.3.1 BUTTERFLY 4000

BUTTERFLY 4000 is a strength training machine that is designed for strengthening the abdominal muscles by pulling the arms together in front of the body. The training strain is controlled using plug-in weights. The seat height adjustment allows users to train the three different types of chest muscles individually.

4.3.2 CHEST PRESS 4000

CHEST PRESS 4000 is a strength training machine that is designed for strengthening the chest and arm extensor muscles by bench pressing in a sitting position. The training strain is controlled using plug-in weights. The seat height adjustment as well as the different handle variations allow for multiple training.

4.4 Upper arm muscles

4.4.1 BICEPS FLEXION 4000

BICEPS FLEXION 4000 is a strength training machine that is designed for strengthening the arm flexion muscles by angling the arms while in a sitting position. The training strain is controlled using plug-in weights. The seat height adjustment allows users to set an optimal training position.

4.4.2 TRICEPS EXTENSION 4000

TRICEPS EXTENSION 4000 is a strength training machine that is designed for strengthening the arm extension muscles by stretching the arms while in a sitting position. The training strain is controlled using plug-in weights. The seat height adjustment allows users to set an optimal training position.

4.5 Abdominal muscles

4.5.1 ABDOMINAL FLEXION 4000

ABDOMINAL FLEXION 4000 is a strength training machine that is designed for strengthening the abdominal muscles by bending the upper body while in a sitting position. The training strain is controlled using plug-in weights. Regular workouts on this machine prevent postural deficiencies and spinal column arthrosis.

4.5.2 ABDOMINAL TORSION 4000

ABDOMINAL TORSION 4000 is a strength training machine that is designed for strengthening the lateral abdominal muscles by a rotation of the upper body while restraining the lower body. The training strain is controlled using plug-in weights.

4.6 Pelvic muscles

4.6.1 ABDUCTOR 4000

ABDUCTOR 4000 is a strength training machine that is designed for strengthening the outer thigh muscles by spreading the legs. The training strain is controlled using plugin weights.

4.6.2 ADDUCTOR 4000

ADDUCTOR 4000 is a strength training machine that is designed for strengthening the inner thigh muscles by closing the legs. The training strain is controlled using plugin weights.

4.6.3 HIP EXTENSION 4000

HIP EXTENSION 4000 is a strength training machine that is designed for strengthening the gluteal muscles by stretching the leg while the knee is bent. The training strain is controlled using plug-in weights. Regular workouts on this machine prevent an unstable hip joint.

4.7 Thigh muscles

4.7.1 LEG EXTENSION 4000

LEG EXTENSION 4000 is a strength training machine that is designed for strengthening the front thigh muscles by stretching the legs. The training strain is controlled using plug-in weights. Regular workouts on this machine prevent an unstable knee joint.

4.7.2 LEG FLEXION 4000

LEG FLEXION 4000 is a strength training machine that is designed for strengthening the back thigh muscles by bending the legs. The training strain is controlled using plug-in weights. Regular workouts on this machine prevent an unstable knee joint.

4.7.3 SQUAT PRESS 4000

LEG PRESS 4000 is a strength training machine that is designed for strengthening thigh and gluteal muscles by performing leg presses while in a sitting or lying position. The training strain is controlled using plug-in weights. Regular workouts on this machine prevent an unstable knee joint.

4.8 Multifunctional

4.8.1 CABLE 4000 / CABLE 4000 FREE

CABLE 4000 is an explosion cable tower offering a facet of exercises for the upper and lower body. The athlete can pull in different directions. It can be mounted on the wall or placed on the floor. The training strain is controlled using plug-in weights.

4.8.2 CABLE CROSSOVER 4000

CABLE CROSSOVER 4000 is a strength training machine that offers multiple exercises for the upper and lower body by lat pulling combined with different exercises. The workout may be carried out unilaterally or bilaterally and the pulling direction is variable. The training strain is controlled using plug-in weights.

4.8.3 CABLE TOWER 4000

CABLE TOWER 4000 is a strength training machine consisting of various exercise stations which allow several people to train simultaneously. Users can perform lat pulling, lat pulldown, rowing, bicep and tricep exercises. This allows you to train the majority of your upper and lower body muscles with just one exercise machine. The training strain is controlled using plug-in weights.

4.8.4 MULTI PRESS 4000

MULTI PRESS 4000 is a strength training machine that offers multiple exercises for the torso, arms and legs. Training position and strain are variable. The machine is equipped with safety supports and weight rests.

4.8.5 PULL UP/DIP 4000

PULL UP/DIP 4000 is a strength training machine consisting of a chin-up and a dip machine. It assists the trainee during the respective exercises and strengthens the back, chest and arm muscles.

4.8.6 SEATED DIP 4000

The SEATED DIP 4000, a resistance machine, is designed for dip exercises in seated position. It supports the athlete's training performance and strengthens the triceps as well as parts of the shoulder and chest muscles.

4.9 Benches

4.9.1 ABDOMINAL BENCH 4000

ABDOMINAL BENCH 4000 is an exercise bench which creates all conditions for sustainable training of the abdominal muscles. It facilitates a more stable training posture. The variable back pad ensures an optimal training position.

4.9.2 BACK BENCH 4000

BACK BENCH 4000 is a special back exercise bench that trains and strengthens both the back and the gluteal muscles in a position of 45°. The adjustable leg pad allows the user to adapt the machine to any body height. A second pad allows the user to restrain his legs, which ensures a stable training position.

4.9.3 FLAT BENCH 4000

FLAT BENCH 4000 supports a great number of exercises for the upper and lower body muscles as well as free barbells training. It supports a better training position.

4.9.4 MULTI BENCH 4000

MULTI BENCH 4000 is a training bench that supports a great number of exercises for the upper and lower body muscles as well as free weight training. It supports a better training position. The back pad adjustment allows the user to set an optimal training position.

4.9.5 OLYMPIC FLAT BENCH 4000

OLYMPIC FLAT BENCH 4000 trains arm and chest muscles and is equipped with a stable pad and a safety support for weights.

4.9.6 OLYMPIC INCLINE BENCH 4000

OLYMPIC INCLINE BENCH 4000 efficiently strengthens arm and chest muscles. Back rest and variable seat height support and optimal training position. The bench is also equipped with a safety support for weights.

4.9.7 SCOTT BENCH 4000

SCOTT BENCH 4000 trains the arm muscles in a seated position while the upper body is fixed. It is equipped with a vertically adjustable seat and a safety support for weights.

4.9.8 SQUAT RACK 4000

SQUAT RACK 4000 is a knee bend rack to train different muscle groups. Training position as well as training load are variable. In addition, the SQUAT RACK offers safety supports as well as racks for weights.

Chapter 5 Transport and Setup

5.1	Transport	22
5.2	Setup Location and Installation	22
5.3	Mounting	23
5.4	Ambient temperature	24
5.5	Plugging In	24
5.5.1	Power Supply	24
5.5.2	Cabeling	25
5.6	Components	25
5.6.1	Back muscles	25
5.6.1.1	BACK EXTENSION 4000	25
5.6.1.2	BACK PULL 4000	26
5.6.1.3	BUTTERFLY REVERSE 4000	26
5.6.1.4	LAT PULL 4000	27
5.6.2	Shoulder muscles	27
5.6.2.1	SHOULDER ABDUCTION 4000	27
5.6.2.2	SHOULDER PRESS 4000	28
5.6.3	Chest muscles	28
5.6.3.1	BUTTERFLY 4000	28
5.6.3.2	CHEST PRESS 4000	29
5.6.4	Upper arm muscles	29
5.6.4.1	BICEPS FLEXION 4000	29
5.6.4.2	TRICEPS EXTENSION 4000	30
5.6.5	Abdominal muscles	30
5.6.5.1	ABDOMINAL FLEXION 4000	30
5.6.5.2	ABDOMINAL TORSION 4000	31
5.6.6	Pelvic muscles	31
5.6.6.1	ABDUCTOR 4000	31
5.6.6.2	ADDUCTOR 4000	32
5.6.6.3	HIP EXTENSION 4000	32
5.6.7	Thigh muscles	33
5.6.7.1	LEG EXTENSION 4000	33
5.6.7.2	LEG FLEXION 4000	33
5.6.7.3	SQUAT PRESS 4000	34
5.6.8	Multifunctional	35
5.6.8.1	CABLE 4000	35
5.6.8.2	CABLE CROSSOVER 4000	35
5.6.8.3	CABLE TOWER 4000	36
5.6.8.4	MULTI PRESS 4000	36
5.6.8.5	PULL UP/DIP 4000	37
5.6.8.6	SEATED DIP 4000	37
5.6.9	Benches	38
5.6.9.1	ABDOMINAL BENCH 4000	38
5.6.9.2	BACK BENCH 4000	38
5.6.9.3	FLAT BENCH 4000	39
5.6.9.4	MULTI BENCH 4000	39
5.6.9.5	OLYMPIC FLAT BENCH 4000	40
5.6.9.6	OLYMPIC INCLINE BENCH 4000	40
5.6.9.7	SCOTT BENCH 4000	41
5.6.9.8	SQUAT RACK 4000	41

5 Transport and Setup

Please note: This owner's manual contains information on multiple gym machines. There may be variations in detail according to the type of machine!

5.1 Transport

In order to avoid damage, ERGO-FIT machines are transported by ERGO-FIT GmbH & Co. KG directly or by an authorised freight forwarding company. After delivery, packaging will be collected and disposed of professionally. If ERGO-FIT machines are delivered by a freight forwarder, the customer needs to dispose of the packaging himself or can send it back to ERGO-FIT GmbH & Co. KG (the customer is responsible for the transportation costs).

5.2 Setup and the right place for setup

1. Make sure that the surface underneath the machine is flat and level.

The machines are mounted and set up directly by the manufacturer or an authorised service technician. Only this way can a safe and proper function of the machine be guaranteed.

2. For safety reasons, please leave enough space around the machine for the user to move safely and to avoid that bystanders are hurt by moving parts: Seen from the access orientation, maintain a clearance of at least the training space plus 0,6 m. Provide enough space for an emergency disassembly. Adjacent machines may use the same clearance.

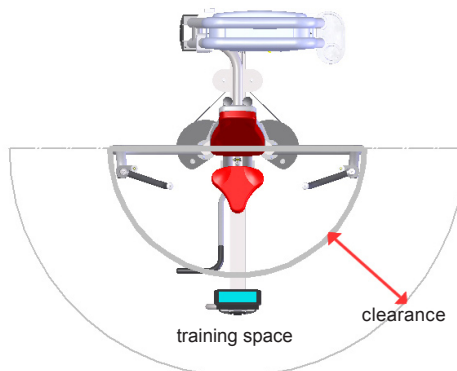

4. Set up the machine so that power switch and plug can easily be disconnected (POWER LINE 4000/4100 S).
5. Remove the transport locks located under the first three weight plates.
6. Perform a function test after setup or relocation.

5.3 Mounting

- ⊗ Please note: Wall mounting of the CABLE 4000 must be performed by an authorized technician. ERGO-FIT GmbH & Co. KG will not be liable for the wall mounting. Use the 4 mounting points to mount the CABLE 4000. The minimum clamping force of each bolt must be 200 N.
- ⊗ In order to mount the gallows you first have to remove the cover and the fin plugs (if applicable). Then slide the gallows into the corresponding rail and fasten it with the provided bolts and nuts. Finally remount the cover.

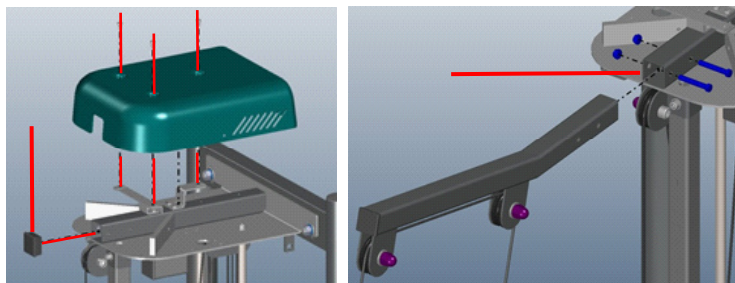

When the equipment is not used any cables that hang down from the gallows must be removed from the workout area. Use a carabiner to join the cables and hook them into the hole in the cover.

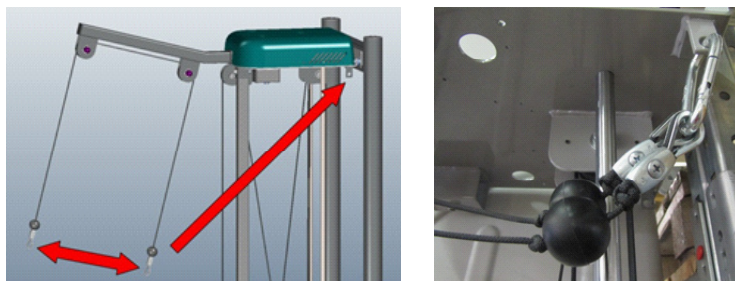

5.4 Ambient Temperature

- ⊗ Your ERGO-FIT exercise machine may be used at an ambient temperature of +10°C to +40°C, a relative humidity of 30 to 75% (non condensing) and an atmospheric pressure of 700 hPa to 1060 hPa without a problem.
- ⊗ The machine may be stored at a temperature between -30°C and +50°C.

5.5 Plugging in (POWER LINE 4100 only)

1. Perform a visual inspection of the power cord and the input connector (power entry module) before using the machine. Damaged power cords and connectors need to be replaced immediately.
2. Plug the power cord into the appropriate power entry module. Plug the other end of the cable into the power outlet.
3. Switch on the machine by pressing the power button (I = ON, O = OFF).
4. After your exercise machine has been connected to mains and switched on, it automatically carries out an operating check. During this operating check, you will be able to read the software version of the unit on the display. Thereafter the main menu will appear.
5. Stand on the side of the control panel (view onto the display) and check if the display works. If this is not the case, make sure you followed the steps above correctly. In addition, verify if there is electricity in the mains socket.

5.5.1 Power Supply

Use your exercise machine only with earthed (grounded) power sockets with 230 VAC / 50-60 Hz (see chapter A5). If you have any doubts about the power supply at the setup location, ask your energy provider. Only use commercial 10 ampere automatic circuit breakers (type B tripping characteristic). In the rare event that these automatic circuit breakers should switch off when you switch on your machine, the circuit needs to be fused with 10 A (16 A with TRAC) lead fuses or with a different type of tripping fuse (e.g. K-automat). In case of doubt, ask your electrician.

Before connecting your ERGO-FIT exercise machine to your power supply system, compare the acceptable voltage and frequency on the name plate (next to power entry module) with your local data.

Always connect your machine directly to the power outlet. Do not use extension cables or multi-outlet power strips unless they are EN 60601-1 certified.

We recommend DC-isolated cables for the connection of external equipment to a POWER LINE 4000/4100 MED machine.

5.5.2 Cabeling

If you have connected several ERGO-FIT machines to one circuit never switch on multiple machines.

- ⊗ Make sure that nobody can step on or stumble across the power cord.
- ⊗ Do not place any objects on the cord as it might get damaged.

5.6 Components

5.6.1 Back muscles

5.6.1.1 BACK EXTENSION 4000

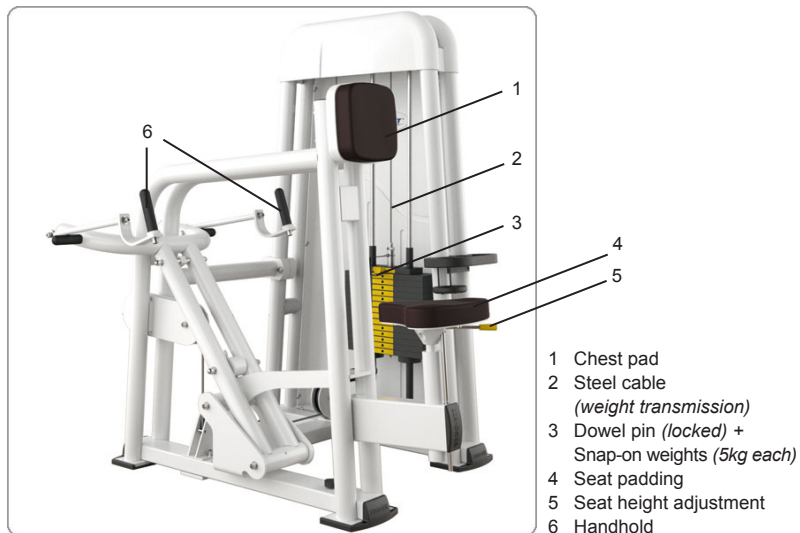
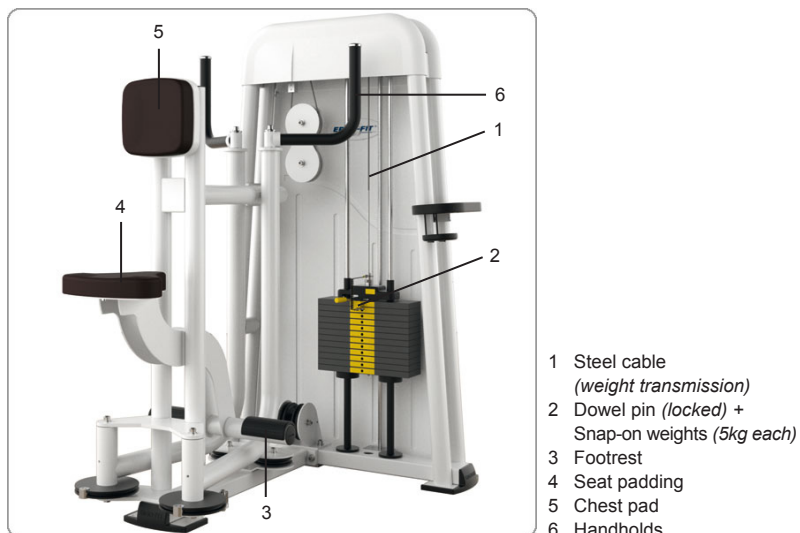

- 1 Steel cable
(*weight transmission*)
- 2 Eccentric
- 3 Snap-on weights (5kg each)
+ Dowel pin (*locked*)
- 4 Handhold
- 5 Seat padding
- 6 Back support

5.6.1.2 BACK PULL 4000

5.6.1.3 BUTTERFLY REVERSE 4000

5.6.1.4 LAT PULL 4000



- 1 Steel cable
(weight transmission)
- 2 Dowel pin (locked) +
Snap-on weights (5kg each)
- 3 Seat padding +
Seat height adjustment
- 4 adjustable Leg pad
- 5 Handholds

5.6.2 Shoulder muscles

5.6.2.1 SHOULDER ABDUCTION 4000



- 1 Steel cable
(weight transmission)
- 2 Dowel pin (locked)+
Snap-on weights (5kg each)
- 3 Seat padding
- 4 Seat height adjustment
- 5 Handhold
- 6 Arm padding

5.6.2.2 SHOULDER PRESS 4000



- 1 Steel cable
(weight transmission)
- 2 Dowel pin (locked) +
Snap-on weights (5kg each)
- 3 Seat height adjustment
- 4 Seat padding
- 5 Back pad
- 6 Handhold

5.6.3 Chest muscles

5.6.3.1 BUTTERFLY 4000

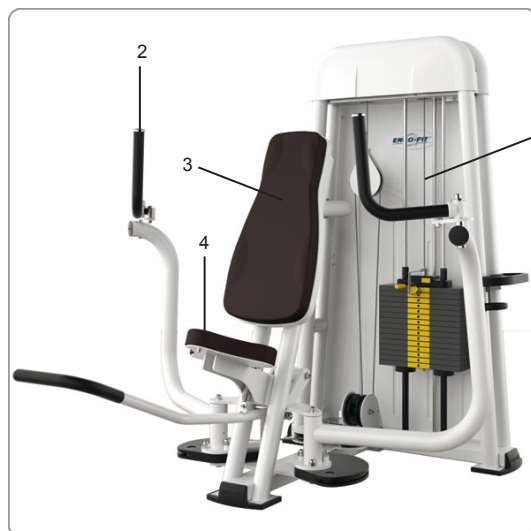

- 1 Steel cable
(weight transmission)
+ Dowel pin (locked) +
Snap-on weights (5kg each)
- 2 Handhold
- 3 Back pad
- 4 Seat padding

5.6.3.2 CHEST PRESS 4000



- 1 Steel cable
(weight transmission)
+ Dowel pin (locked) +
Snap-on weights (5kg each)
- 2 Handhold
- 3 Seat padding
- 4 Seat height adjustment
- 5 Easy entry feature
- 6 Back pad

5.6.4 Upper arm

5.6.4.1 BICEPS FLEXION 4000

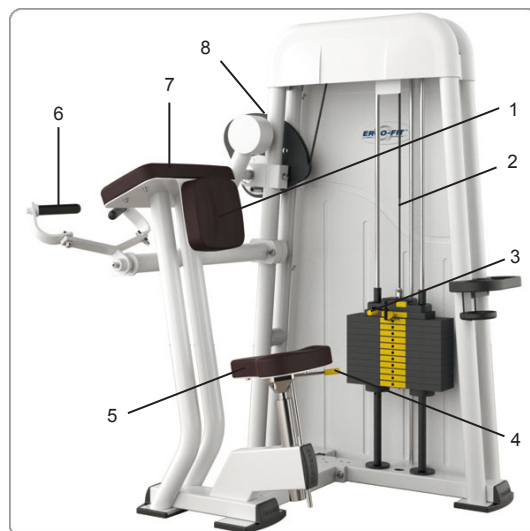

- 1 Chest pad
- 2 Steel cable
(weight transmission)
- 3 Dowel pin (locked) +
Snap-on weights (5kg each)
- 4 Seat height adjustment
- 5 Seat padding
- 6 Handhold
- 7 Upper arm pad
- 8 Eccentric

5.6.4.2 TRICEPS EXTENSION 4000

- 1 Back pad
- 2 Steel cable
(weight transmission)
+ Dowel pin (locked) +
Snap-on weights (5kg each)
- 3 Seat padding with
Seat height adjustment
- 4 Eccentric
- 5 Upper arm pad
- 6 Handhold

5.6.5 Abdomen muscles
5.6.5.1 ABDOMINAL FLEXION 4000

- 1 Steel cable
(weight transmission)
- 2 Seat padding
- 3 Dowel pin (locked) +
Snap-on weights (5kg each)
- 4 Foot rest
- 5 Handhold
- 6 Chest pad
- 7 Eccentric

5.6.5.2 ABDOMINAL TORSION 4000



- 1 Steel cable
(weight transmission)
+ Dowel pin *(locked)* +
Snap-on weights *(5kg each)*
- 2 Thigh restraint
- 3 Seat padding
- 4 Upper arm restraint
- 5 Handhold
- 6 Back pad

5.6.6 Pelvic muscles

5.6.6.1 ABDUCTOR 4000

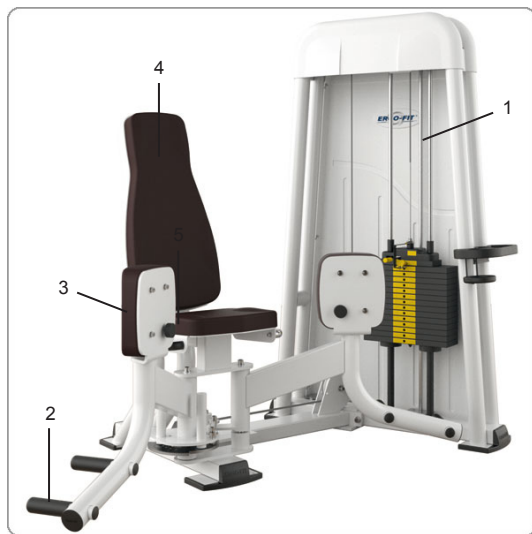

- 1 Steel cable
(weight transmission)
- 2 Dowel pin *(locked)* +
Snap-on weights *(5kg each)*
- 3 Knee pad
- 4 Foot rest
- 5 Seat padding
- 6 Back pad

5.6.6.2 ADDUCTOR 4000

- 1 Steel cable
(*weight transmission*) +
Dowel pin (*locked*) +
Snap-on weights (*5kg each*)
- 2 Foot rest
- 3 Knee pad
- 4 Back pad
- 5 Seat padding

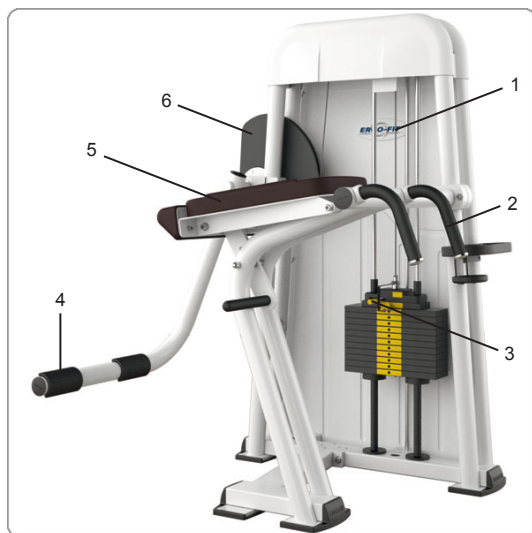
5.6.6.3 HIP EXTENSION 4000

- 1 Steel cable
(*weight transmission*)
- 2 Handhold
- 3 Dowel pin (*locked*) +
Snap-on weights (*5kg each*)
- 4 Foot rest
- 5 Upper body restraint
- 6 Eccentric

5.6.7 Thigh muscles

5.6.7.1 LEG EXTENSION 4000



- 1 Steel cable
(weight transmission)
+ Dowel pin (locked) +
Snap-on weights (5kg each)
- 2 Foot pad
- 3 Handhold
- 4 Seat padding
- 5 Eccentric
- 6 Back pad

5.6.7.2 LEG FLEXION 4000

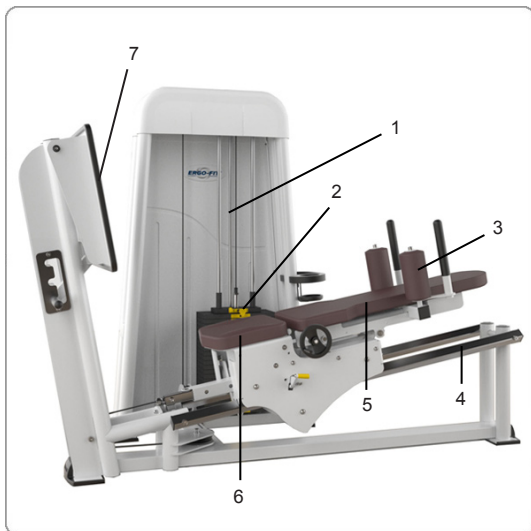

- 1 Steel cable
(weight transmission) +
+ Dowel pin (locked) +
Snap-on weights (5kg each)
- 2 Handhold
- 3 Foot pad
- 4 Seat padding
- 5 Thigh restraint
- 6 Back pad

5.6.7.3 SQUAT PRESS 4000

- 1 Steel cable
(weight transmission)
- 2 Dowel pin *(locked)* +
Snap-on weights *(7,5 kg each)*
- 3 Shoulder pad
- 4 Guide rail
- 5 Back pad
- 6 Seat padding
- 7 Foot support

5.6.8 Multifunctional

5.6.8.1 CABLE 4000

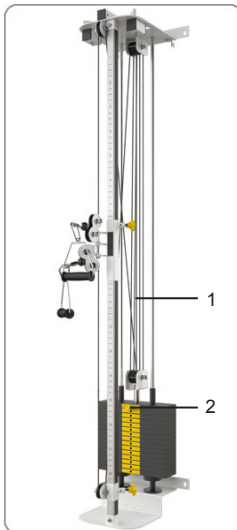

Please note: Wall mounting of the CABLE 4000 must be performed by a skilled technician. ERGO-FIT GmbH & Co. KG will not be liable for wall mounting. CABLE 4000 must be attached to 4 fixing points, the bolt retention force must be 200N.

- 1 Kevlar cable
(weight transmission)
- 2 Dowel pin (locked) +
Snap-on weights (5kg each)

5.6.8.2 CABLE CROSSOVER 4000



- 1 Steel cable
(weight transmission)
- 2 Dowel pin (locked)+
Snap-on weights (5kg each)
- 3 Handholds

5.6.8.3 CABLE TOWER 4000

Bring the machine to the desired place and adjust the same. Then attach the rubber pads to the base plates and fix the seat and the seat bench by the clamp collar on the frame. Turn the feet down until the machine has a stable position on the floor. Then tighten the clamp collars at the seat and the seat bench. Finally, test again the feet for a stable position and readjust the same if necessary.

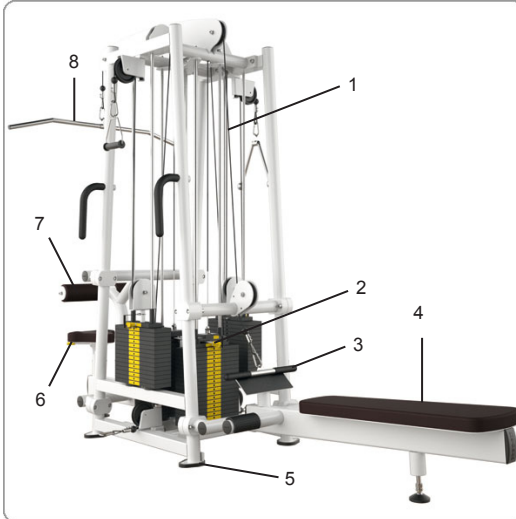

- 1 Steel cable + Flat belt (weight transmission)
- 2 Dowel pin (locked) + Snap-on weights (5kg each)
- 3 Handholds Rowingstation
- 4 Seat padding
- 5 Foot support
- 6 Seat pad
- 7 Thigh restraint
- 8 Lat pulldown

5.6.8.4 MULTI PRESS 4000



- 1 Dumbbell bar
- 2 Weight storage bar
- 3 Seat / lying pad
- 4 Guide rail (with safety holder)

5.6.8.5 PULL UP/DIP 4000



- 1 Pull up handhold
- 2 Dip handhold
- 3 Steel cable
(*weight transmission*)
+ Dowel pin (*locked*) +
Snap-on weights (*7,5kg each*)
- 4 Foot rest
- 5 Knee pad

5.6.8.6 SEATED DIP 4000



- 1 Back pad
- 2 Steel cable
(*weight transmission*)
+ Dowel pin (*locked*) +
Snap-on weights (*7,5kg each*)
- 3 Handhold
- 4 Seat padding with
Seat height adjustment
- 5 Back pad adjustment

5.6.9 Benches**5.6.9.1 ABDOMINAL BENCH 4000**

- 1 Back pad
- 2 Back pad adjustment
- 3 Foot support

5.6.9.2 BACK BENCH 4000

- 1 Leg pad
- 2 Leg restraint
- 3 Leg pad adjustment

5.6.9.3 FLAT BENCH 4000



1 Seat/lying pad

5.6.9.4 MULTI BENCH 4000



1 Back pad
2 Seat pad
3 Seat padding adjustment

5.6.9.5 OLYMPIC FLAT BENCH 4000

- 1 Seat/lying pad
- 2 Safety support for weights

5.6.9.6 OLYMPIC INCLINE BENCH 4000

- 1 Back pad
- 2 Seat padding
- 3 Seat padding adjustment
- 4 Safety support for weights

5.6.9.7 SCOTT BENCH 4000



- 1 Upper arm pad
- 2 Safety support for weights
- 3 Seat padding adjustment
- 4 Seat padding

5.6.9.8 SQUAT RACK 4000



- 1 Safety support for weights
- 2 Racks for weights

Chapter 6 Setup

6.1	Switching On	43
6.2	Switching Off	43
6.3	The Control Panel (POWER LINE 4100 only)	43
6.3.1	The Buttons	45
6.4	Calibrating the Weight Plates	46
6.5	Resistance adjustment	46
6.5.1	Additional Weight	46
6.6	Eccentric function	47
6.7	Function test	48

Please note:

This user manual provides information on several devices.
Details may vary depending on your model!

6 Setup

Connect your machine directly to the power outlet (110...220 V AC). Always connect your machine directly to the power outlet. Do not use extension cables or multi-outlet power strips unless they are EN 60601-1 certified. After switching on the machine have to wait 35 minutes before you can use the machine. During this warm-up period you can adjust the weight plates. After the warm-up period the weight plates should be correctly displayed in the Cockpit. You can now start your workout. We recommend DC-isolated cables for the connection of external equipment to a POWER LINE 4000 MED machine.

6.1 Switching On

- ⊗ Before switching on your exercise machine, make sure the machine is plugged in.
- ⊗ If you have connected several ERGO-FIT machines to one circuit never switch on multiple machines at the same time. Otherwise technical problems might occur.
- ⊗ Now switch on your machine by pressing the switch next to the power entry module. The switch must be in position I. If the switch is in position O the machine is switched off:
- ⊗ The illumination of the display shows you immediately if the machine is switched on.

6.2 Switching Off

- ⊗ Switch off your machine by pressing the switch next to the power entry module. The switch must be in position O.

Take care that the switch-on and switch-off intervals don't fall below a time of 3 sec.

6.3 The Control Panel (POWER LINE 4100 only)

ERGO-FIT exercise equipment is known for its outstanding ease of use. POWER LINE4100 S/S MED control panels (panel pc's) for example are equipped with a user guidance system that is simple and easy to understand. The Panel PC can only be operated by touching the buttons.

The Panel PC consists of a display, some buttons and a chip card reader. Before you take a closer look at the control panel please consider the following aspects:

1. Do not lean on the control panel or the display. It may get damaged.
2. Only press the buttons lightly. When you press a button you will hear a beep.
3. The chip card reader of the POWER LINE 4100 series is a very sensitive component. To avoid failure during long-term usage make sure to carefully insert chip cards into the card reader. When you insert the card you have to be able to read the labeling when standing / sitting on the machine. The arrows on the left of the corporate symbol indicate the direction of insertion. The chip card reader's lifetime is about 100 000 insertion cycles.



6.3.1 The Buttons

Depending on the displayed panel you will find different buttons on the Panel PC. Please refer to the following list of the most important buttons to understand their function:

- ⊗ PLUS: With this button you can increase the intensity or change parameters.
- ⊗ MINUS: With this button you can decrease the intensity or change parameters.
- ⊗ START: With this button you can confirm workout mode selections or parameter settings.
- ⊗ STOP: With this button you can cancel a function or stop the machine.
- ⊗ BACK: : Return to the previous panel.
- ⊗ NEXT: Go to the next panel.

6.4 Calibrating the Weight Plates

Before any new calibration/re-calibration of the weight plates you have to consider a warm-up period of 35 minutes. The warm-up period starts as soon as you switch on the machine. Re-calibration is only possible after the warm-up period has finished. Otherwise the weight plates may be displayed incorrectly in the Cockpit or may adjust automatically.

Note: The workout machine with laser sensor is a precision measuring instrument. But even here you have to consider measuring tolerances due to environmental factors (temperature changes, operation time etc.). Therefore, we recommend to check the functionality of the machine regularly. In case of a the weight plate difference you have to perform a re-calibration.

6.5 Resistance adjustment

On all machines of the POWER LINE4000 series the resistance can be adjusted by adding or reducing the number of snap-on weights. Dowel pins are used to adjust the weight by inserting them into the borings in the snap-on weights. The weights may be chosen directly from the machine.

When adjusting, consider the following aspects:

- ⊗ You can only adjust the weights when the weight bundle is not under tensile stress and the snap-on weights are resting firmly. Accordingly, you should avoid modifying the training weight during a motion sequence.
- ⊗ Make sure to insert the dowel pins completely. If this is not the case, the pins might loosen during motion. The snap-on weights can fall on the weight bundle and this might damage the weights or injure the trainee because of jerky removal of the load.
- ⊗ To secure the weights, insert the dowel pins straight into the borings. Otherwise, the dowel pins might tilt during motion.
- ⊗ Do not put your hands between the snap-on weights. Otherwise, there is a risk of injury
- ⊗ Do not let the weights impact on the weight bundle during and after exercise. Always make sure that the weights fall smoothly on the bundle.

6.5.1 Additional Weight

Equipment with MED labeling provides an additional weight (2.5 kg) which can be added as needed. Um dies zu tun müssen Just turn the yellow lever at the top of the weight stack.



Additional Weight not added



Additional Weight added

CABLE 4000 MED/S MED use pulleys to add weight. Using a carabiner, hook the lower cable in the upper eyelet. The cable pulleys have to be positioned vertically and the cable must run upwards through all pulleys.

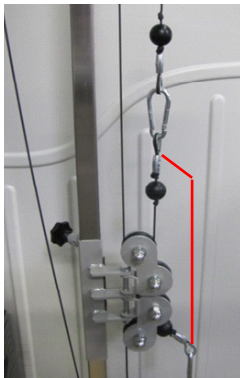

Run the cable upwards through all pulleys

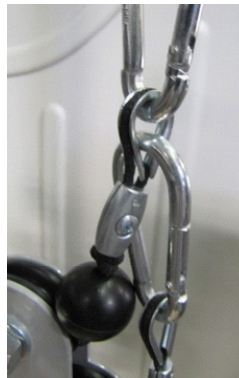

Attaching the carabiner to the eyelet



Cable pulleys have to be positioned vertically

6.6 Eccentric function

When designing strength training machines, strength curves are often made use of. The aim of considering strength curves is to ensure the correct and targetted adjustment of the resistance for the respective abilities of the muscle to be trained. This means concretely that training stimuli can be used optimally by almost all parts of a muscle.

The technological aid for this purpose is the eccentric technique. The eccentric is connected with the rotation axis of the exercise machine via which the load of the training weight is transferred to the lever arm (moment arm) that is moved by the trainee. The set weight is

transferred to the outer border of the eccentric disc via a flat belt.

The edge of the eccentric does not form a concentric radius (constant distance between outer edge and rotation axis) around the rotation point of the disc but an eccentric radius (variable distance between outer edge and rotation axis). The distance between the respective surface location of the weight plate (load) and the rotation point determines the length of the lever arm with which the weight pulls the plate. This distance is called the load arm. In contrast, the length of the lever arm (against which the trainee works) determines the so-called moment arm. According to the lever principle ($\text{Load} \times \text{load arm} = \text{moment} \times \text{moment arm}$), an eccentric transfers a high torque (more load) on the rotation axis if the weight is transferred via a long load arm to the rotation axis and vice versa (i.e. via a point of the disc with a longer distance to the rotation point). Thus, the maximum strain on the muscles may be realised by a high torque already at the beginning of the motion and will be maintained almost until the final position is reached.



Eccentric (example: LEG EXTENSION 4000)

To meet individual needs, the moment arm may be adjusted in relation to the eccentric to allow for strain adjustment by modifying the link positions.

Some machines of the POWER LINE 4000 are not equipped with an eccentric. This is due to the vertical (LAT PULL 4000, SHOULDER ABDUCTION 4000, SHOULDER PRESS 4000) or horizontal (CHEST PRESS 4000, LEG PRESS 4000) exercise motion.

6.7 Function test

Function test: How to proceed:

- ⊗ Check if all handling parts are locked properly before training. Make sure there are no loose or badly mounted handling parts.
- ⊗ Check the cable and wires for damage.
- ⊗ Check moving parts (steel cables, Kevlar cables, rollers) for proper function.
- ⊗ Check the rests and paddings for damage.
- ⊗ Check if all adjustable parts function properly.

Chapter 7 Operation POWER LINE 4100

7.1	Operation Modes	50
7.1.1	Manual	50
7.1.2	System	50
7.1.3	Test	52
7.2	Default settings	53

Please note:

This user manual provides information on several devices.
Details may vary depending on your model!

7 Operation (POWER LINE 4100 only)

7.1 Operation Modes POWER LINE 4100

The Panel PC always starts in Start mode. Here you can choose Manual Workout or insert your personal chip card to start chip card workout or a fitness test. After 30 seconds of inoperation the Panel PC automatically switches to standby and starts the screen saver. By touching the display you return to the start mode.

7.1.1 Manual

In this mode you can select any workout time and choose any workload level or repetition.

1. Press the MANUAL button.
2. The "Machine Settings" screen is displayed. Adjust the device (seat etc.) and choose your workout load. Confirm your settings by pressing START. BACK returns you to the start mode.
3. Now set your personal movement range. Get into the start position. After a 5 second countdown you will be asked to perform the exercise 3 times. Now the Panel PC determines your personal movement range for the workout and enters it into the subsequent workout mode. Press STOP to cancel this procedure.
4. You now access the workout mode. The Cockpit displays the number of completed sets and repetitions. The movement range determined at the beginning will be illustrated by a column. The target speed for the exercise is illustrated by a grey frame, the actual speed by a green bar. Repetitions are only valid if the determined movement range is reached (green area in the upper and lower area of the graphic).
5. You can pause the workout after any number of repetitions by pressing the STOP button. You will access the pause mode.
6. You can pause the workout as long as you want to. The actual duration of the pause will be displayed in the monitor. Press the CORRECT button to return to the machine settings. Here you can change any parameters. To continue the workout just start moving. You can repeat this procedure as often as you want to. Press the STOP button to end the exercise. You will then see a summary of your workout. Press the STOP button again to return to the start mode

7.1.2 System

To use the System mode you first have to set up a workout schedule and write this schedule on a Training Card which must be initialized at the Vitality Coach.

Only Vitality Explorer users with Expert Customer privileges can modify device setup and exercise parameters.

1. Insert your training card into the chip card reader to start a chip card workout. The Machine Settings window opens.
2. Here you find all setup options for the device plus the workout settings for the specific user. Adjust the device according to the given parameters. You can change the settings. Touch the setting you want to change. It will then be highlighted according to your color scheme. Press the PLUS and MINUS buttons to modify the setting. Press NEXT to confirm the changes, or press BACK to return to the start mode.
3. You are now in the parameter section. The displayed settings depend on the workout type (dynamic, static or countdown). Confirm your selection with NEXT. Touch the setting you want to change. It will then be highlighted according to your color scheme. Press the PLUS and MINUS buttons to modify the setting. The changes apply to all subsequent sets. If you want to use different settings for the subsequent sets, use the arrow key to select the corresponding set and then change the settings. When you are finished confirm your changes by pressing NEXT. Or press BACK to return to the start mode.

If you want to change your individual movement range, touch Start Position. Get into start position. After a few seconds your position will be stored and End Settings will be highlighted. Get into end position. After a few seconds this position will also be stored and the highlight will disappear.

4. The device now check the load setting. You will be notified, if the load setting does not correspond to the load on the chip card. Correct the load setting and press NEXT.
5. You now access the workout mode. The display depends on the workout mode:
 - a) dynamic workout The Cockpit displays the number of completed sets and repetitions. The movement range determined at the beginning will be illustrated by a column. The target speed for the exercise is illustrated by a grey frame, the actual speed by a green bar. Repetitions are only valid if the determined movement range is reached (green area in the upper and lower area of the graphic).
 - b) static workout: The Cockpit displays the remaining hold duration. The target hold duration for the exercise is illustrated by a grey frame, the actual hold duration by a green bar. The hold duration will only be accepted within the set end position (grey frame). If you leave the hold position the hold duration will stop and Lift will be displayed. At the end of the hold duration Release will be displayed.
 - c) countdown workout: The Cockpit displays the number of completed sets and repetitions and the remaining countdown. The actual exercise speed is represented by a green bar. Repetitions are only valid if the determined movement range is reached (green area in the upper and lower area of the graphic).
6. When all conditions are met (repetitions or end of countdown) or if you press STOP you access the PAUSE mode.
7. The predefined duration of the pause will be displayed in the monitor. Press the CORRECT button to return to the exercise settings. Here you can change any parameters. At the end of the pause mode you will return to the workout mode.

Press CONTINUE to continue the workout immediately. Press STOP to continue the workout later. Or press END to cancel the workout. In this case you cannot continue the workout.

8. After pressing END or if you have completed the predefined sets the Perceived Exertion window will be displayed. Here you can describe your perceived exertion. Confirm your selection with NEXT.
9. Finally, successful repetitions, total weight lifted and average weight lifted per repetition are displayed. Moreover, all exercises are listed that according to the chip card workout schedule still have to be performed. If all exercises are finished the message Training Complete will be displayed. Remove the chip card.

7.1.3 Test

For any fitness test you first need a Test Plan and a Test Card.

1. Insert your test card into the chip card reader to start a strength test.
2. You will see all setup options for the device plus the workout settings for the specific user. Adjust the device according to the given parameters. You can change the settings. Touch the setting you want to change. It will then be highlighted according to your color scheme. Press the PLUS and MINUS buttons to modify the setting. Press NEXT to confirm the changes, or press BACK to return to the start mode.
3. The test parameters of the last variation test will be displayed. You will see repetitions per set, start load, pause (in seconds), speed (in concentric, isometric and eccentric phase in seconds) and movement range. Confirm them with START. Touch the setting you want to change. It will then be highlighted according to your color scheme. Press the PLUS and MINUS buttons to modify the setting. When you are finished confirm your changes by pressing START. Or press BACK to return to the start mode.

If you want to change your individual movement range, touch Start Position. Get into start position. After a few seconds your position will be stored and End Settings will be highlighted. Get into end position. After a few seconds this position will also be stored and the highlight will disappear.

4. The device now check the load setting. You will be notified, if the load setting does not correspond to the load on the chip card. Correct the load setting and press NEXT.
5. You now access the workout mode. The Cockpit displays the number of completed sets and repetitions. The movement range determined at the beginning will be illustrated by a column. The target speed for the exercise is illustrated by a grey frame, the actual speed by a green bar. Repetitions are only valid if the determined movement range is reached (green area in the upper and lower area of the graphic). If your results differ too much from the preset speed and movement range the test will be automatically canceled. You can also stop the test at any time by pressing the STOP button.

6. After completing the preset number of repetitions you access the pause mode where a new workout load will be suggested. Select the suggested weight or any higher weight and confirm with NEXT. When you have selected the new weight you should use the remaining time of the pause mode to recover. The text will be continued automatically.
7. The test will be finished when you press STOP in workout or pause mode. Your results will be displayed on a new screen. Press APPLY to save the results. If you want to perform another test, press REPEAT. If you apply your results you will see your personal power level based on these results. Remove the chip card.

7.2 Default Settings

Insert the F4 card that you have created in the Vitality System main menu. The User Settings menu will be displayed. Here you have various options for administrative settings.

Hardware settings:

To change date, time and units. Touch the setting you want to change. It will then be highlighted according to your color scheme. Press the PLUS and MINUS buttons to modify the setting. When you are finished confirm your changes by pressing SAVE. Or press BACK to return to the User Settings menu.

Laser calibration:

Here you can calibrate the weights if the weight displayed on the Panel PC does not match the weight selected on the device. In the upper section you will see the number of plates and their weight. You start laser calibration with the lowest plate (maximum weight). Select this plate and press SAVE. The Panel PC then displays the next plate and the corresponding weight. Select this plate and press SAVE. This is repeated for each weight plate.

Please note: Always perform a complete weight configuration for all plates, even if only one plate is wrong.

Point calibration:

The point calibration is easier than the laser calibration, but it is not as exact. For point calibration you only need to select one plate. All other distances will be calculated based on the result for this plate. Select the highest plate and press SAVE. You will then automatically return to the User Settings menu.

Language settings:

Touch the language you want to use. It will be checked and highlighted according to your color scheme. Confirm your selection by pressing SAVE. Press BACK to return to the User Settings menu.

Chapter 8 Training

8.1	The effect of training	56
8.2	Strain parameters	56
8.3	Training routine – aspects to be considered	57
8.4	Training tips	58
8.5	Proper training technique	58
8.5.1	Back muscles	59
8.5.1.1	BACK EXTENSION 4000	59
8.5.1.2	BACK PULL 4000	60
8.5.1.3	BUTTERFLY REVERSE 4000	61
8.5.1.4	LAT PULL 4000	62
8.5.2	Shoulder muscles	63
8.5.2.1	SHOULDER ABDUCTION 4000	63
8.5.2.2	SHOULDER PRESS 4000	64
8.5.3	Chest muscles	65
8.5.3.1	BUTTERFLY 4000	65
8.5.3.2	CHEST PRESS 4000	66
8.5.4	Upper arm muscles	67
8.5.4.1	BICEPS FLEXION 4000	67
8.5.4.2	TRICEPS EXTENSION 4000	68
8.5.5	Abdominal muscles	69
8.5.5.1	ABDOMINAL FLEXION 4000	69
8.5.5.2	ABDOMINAL TORSION 4000	70
8.5.6	Pelvic muscles	71
8.5.6.1	ABDUCTOR 4000	71
8.5.6.2	ADDUCTOR 4000	72
8.5.6.3	HIP EXTENSION 4000	73
8.5.7	Thigh muscles	74
8.5.7.1	LEG EXTENSION 4000	74
8.5.7.2	LEG FLEXION 4000	75
8.5.7.3	SQUAT PRESS 4000	76
8.5.8	Multifunctional	78
8.5.8.1	PULL UP/DIP 4000	78
8.5.8.1.1	PULL UP 4000	78
8.5.8.1.2	DIP 4000	79
8.5.8.2	SEATED DIP 4000	80

Please note:

This owner's manual contains information on multiple gym machines.
There may be variations in detail according to the type of machine!

8 Training

8.1 The effect of training

The demands of today's lifestyle in modern societies are not enough to remain in good physical condition. Increasing automation and mechanisation involve an increasing number of activities limited to fine motor skills. This development includes everyday life. Physical inactivity inevitably leads to physical deterioration.

Muscle power allows the human being to stand up against gravity and to carry out movements. However, general prejudices against strength training have suppressed the importance of its promotion and preservation so far. Recent studies show that physical inactivity leads to postural deficiencies, muscle weakness and osteoporosis. A lack of muscle power activities is the cause of this. This leads to malpositions, and these lead to overstraining of the muscles, ligaments and the skeletal system. Irreparable damage to the muscular-skeletal system is the long-term consequence.

Strength training has the potential to counteract this physical deterioration. The effect of strength training is – depending on the target and the fitness - a general increase in power in individual muscles, muscle groups or the entire skeletal muscles with and without muscle growth (muscular hypertrophy). Furthermore, it creates a physical base for the exertion of sports or physical activities, counteracts physical inactivity and related effects, and allows for a faster recovery of working abilities after injuries. In addition, it has a positive indirect effect on the psyche and the appearance. You will feel fit, more agile, and more attractive.

Muscle activity releases energy. This energy is converted into warmth. The body gets warmer. To avoid overheating, the body counteracts this mechanism through perspiration. However, loss of liquid reduces physical capabilities. Sports physicians recommend a regular fluid intake during training to counteract this effect.

8.2 Strain parameters

The following aspects are relevant for general fitness purposes: muscle building training (growth of muscle diameter, increase in maximum strength, firming body tissue) and maintenance of strength performance (strength endurance training: increasing fatigue resistance during stress, firming body tissue).

The general strain levels are.

Muscle building training

	Beginner	Advanced
Intensity (% of maximum strength)	40-60	60-80
Repetitions	8-15	8-15
Break duration (minutes)	1-2	2-4
Sequences	2-3	3-5
Exercise units per week	1-3	3-5
Training mode	slowly, guided	slowly, guided
Number of exercises	5-10	7-15

Strength endurance training

	Beginner	Advanced
Intensity (% of maximum strength)	40-60	60-80
Repetitions	8-15	8-15
Break duration (minutes)	1-2	2-4
Sequences	2-3	3-5
Exercise units per week	1-3	3-5
Training mode	slowly, guided	slowly, guided
Number of exercises	5-10	7-15

8.3 Training routine – aspects to be considered

If you exercise for the first time or restart training after a longer break, your training routine should include the following stages (example):

1. **Warmup:** Carry out a general cardio vascular training (e.g. walking, running, cycling) for 10-15 minutes to prepare your body for the upcoming strain.
2. **Stretching:** Then stretch those muscle groups you are going to strain during workout.
3. **Main routine:** Now start your actual strength training and try to complete your training target. Carry out a warmup on the exercise machine before each exercise sequence to specifically prepare the muscles for the upcoming strain (low intensity, high number of repetitions).

8.4 Training tips

General

- ⊗ If you perform an exercise for the first time, work with little or no weight to familiarise yourself with the motion sequence. Only increase the intensity when you have perfect control over the respective exercise.
- ⊗ Exercise systematically. Make up a training schedule or have somebody else do it for you.
- ⊗ Have someone correct your training every now and then to counteract habitual mistakes.
- ⊗ Choose strains that correspond to your current performance status. Avoid setting strains too high. This might lead to an overstrain or injuries to your musculoskeletal system.
- ⊗ Modify the training routine regularly (at an interval of approx. 6 to 8 weeks). To do so, you can change parameters such as the intensity, number of repetitions, duration of the breaks, training method or the choice of exercise. Lasting training effects will only be achieved by modifying the training routine.
- ⊗ Exercise regularly. However, allow sufficiently long recreational periods. Only regular exercise combined with recovery phases leads to the desired effect.

Training mode

- ⊗ Do not hold your breath during training. Breathe out during the strain sequence and breathe in during the relaxing sequence.
- ⊗ Exercise in an upright position. Avoid over-arching (hyperlordosis) your back.
- ⊗ Always keep your head in line with your spinal column.
- ⊗ Stabilise your hand joints (do not kink your wrists!).
- ⊗ Avoid jerky movements as this might lead to overstrain or injuries.
- ⊗ Stop the workout immediately if you feel a pain during exercise.
- ⊗ 4 Carefully lower the weights during the workout.
- ⊗ Maintain the training position described here for your entire workout.

8.5 Proper training technique

You should always take into account biomechanical considerations when you exercise. This is why we have listed aspects concerning this matter for each of the strength exercise machines in this chapter.

8.5.1 Back muscles

8.5.1.1 BACK EXTENSION 4000

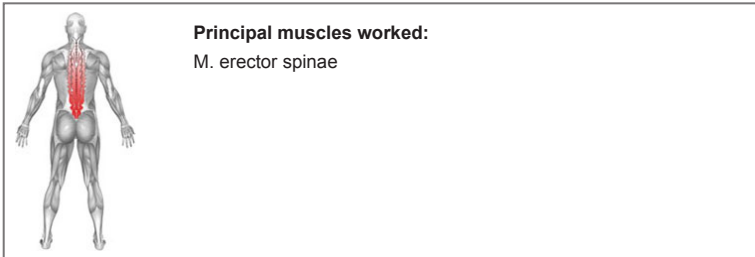

Start position



End position



1. Adopt the right exercise position. Sit on the seat. Your upper body (back straight) leans on the chest padding. Place your feet on the footrests (feet about shoulder width apart) and grasp the lateral handlebars with your hands (see also Chapter 5.4).
2. Now contract the torso muscles and press your straight upper body backwards against the backpad until you are sitting upright. Make sure not to hyperextend your upper body and to keep your pelvis in a stable position. Breathe out when you exert strain against the resistance. Maintain this position momentarily.
3. Now lower your upper body forwards again, making sure to maintain control. Stop the return motion in time so that your torso does not sag downwards. Breathe in during the return sequence.

8.5.1.2 BACK PULL 4000

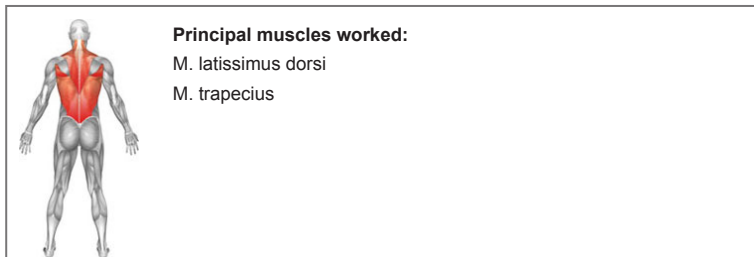

Start position



End position

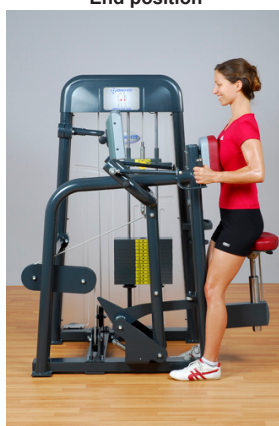

1. Adopt the right exercise position. Sit on the seat. Your upper body (back straight) leans on the chest padding. Place your feet on the footrests (feet about shoulder width apart) and grasp the lateral handlebars with your hands (see also Chapter 5.4).
2. Now contract the torso muscles and press your straight upper body backwards against the backpad until you are sitting upright. Make sure not to hyperextend your upper body and to keep your pelvis in a stable position. Breathe out when you exert strain against the resistance. Maintain this position momentarily.
3. Now lower your upper body forwards again, making sure to maintain control. Stop the return motion in time so that your torso does not sag downwards. Breathe in during the return sequence.

8.5.1.3 BUTTERFLY REVERSE 4000

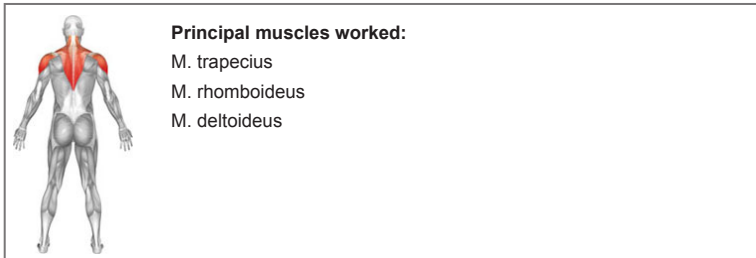

Start position



End position



1. Adopt the right exercise position. Sit on the seat. Your upper body (back straight) leans on the chest padding. Place the balls of your feet on the footrests (feet about shoulder width apart). Extend your arms at shoulder height and grasp the lateral handlebars. The elbows are slightly bent (see also Chapter 5.4).
2. Now contract the torso muscles and pull your arms backwards while maintaining a straight back until your upper arms reach the height of your shoulders. During this movement, pull your shoulder blades together. Make sure not to hyperextend your arms! Breathe out when you exert strain against the resistance. Maintain this position momentarily.
3. Now return the handlebars, making sure to maintain control and stop the return motion when your upper arms are extended in front of you at shoulder width. Breathe in during the return sequence.

Exercise variations: Vary the angle between your arm and torso (adjust the height of the handlebars) to work different areas of the back muscles individually.

8.5.1.4 LAT PULL 4000

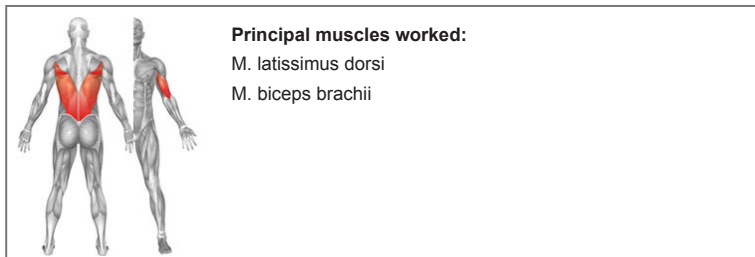

Start position



End position



1. Adopt the right exercise position: Sit on the seat with your upper body upright. Secure your pelvis with the leg pads. Place your feet about shoulder width apart. Grasp the handlebars with your extended arms. The elbows are slightly bent and your palms are facing forwards (see also Chapter 5.4).
2. Now contract your torso muscles and pull your arms downwards against the resistance of the machine until the handles reach the height of your neck. Keep your elbows opened to the sides and pull your shoulder blades together in the final phase. Breathe out when you exert strain against the resistance. Maintain this position momentarily.
3. Now return the handlebars, making sure to maintain control. Stop the return motion in time before the arms are completely extended to avoid increased stress on the elbows. Breathe in during the return sequence.

8.5.2 Shoulder muscles

8.5.2.1 SHOULDER ABDUCTION 4000

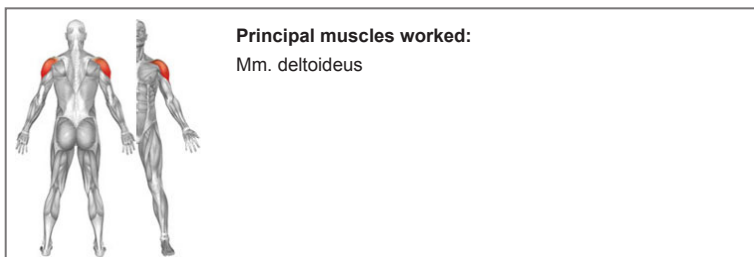

Start position



End position



1. Adopt the right exercise position: Sit on the seat with your upper body upright. The shoulder joint should be at the same height as the rotation axis of the exercise machine. Place your feet about shoulder width apart. Grasp the handlebars with your hands. Your palms are facing each other. Bend your elbows at a right angle. Your forearms touch the inside of the arm pads (also see Chapter 5.4).
2. Now contract your torso muscles, extend your arms sideways and upwards against the resistance of the machine until your arms reach the height of your shoulders. The motion originates from the shoulder joint only. Breathe out when you exert strain against the resistance. Maintain this position momentarily.
3. Now return your arms, making sure to maintain control. Stop the return motion shortly before reaching the torso. Breathe in during the return sequence.

8.5.2.2 SHOULDER PRESS 4000

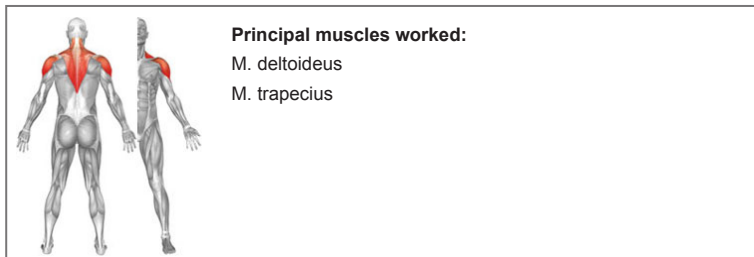

Start position



End position



1. Adopt the right exercise position: Sit on the seat so that your upper body touches the backrest completely. Place your feet about shoulder width apart. Grasp the handlebars with your hands. Your palms show forwards. Bend your elbows at a right angle. Your forearms touch the inside of the arm pads (also see Chapter 5.4).
2. Now contract your torso muscles, extend your arms upwards against the resistance of the machine until your elbow joints are almost completely straight. Make sure not to hyperextend your elbow joints. This may lead to injuries and joint arthrosis in the long term. Breathe out when you exert strain against the resistance. Maintain this position momentarily
3. Now bend your elbows and return the handles, making sure to maintain control. Stop the return motion when the upper arms are in line with the axis of your shoulders. Breathe in during the return sequence.

Exercise variations: Choose a different handlebar position so that your palms are facing each other. Continue the exercise exactly as described above. With this variation, you can increase the effect on the triceps brachii.

8.5.3 Chest muscles

8.5.3.1 BUTTERFLY 4000

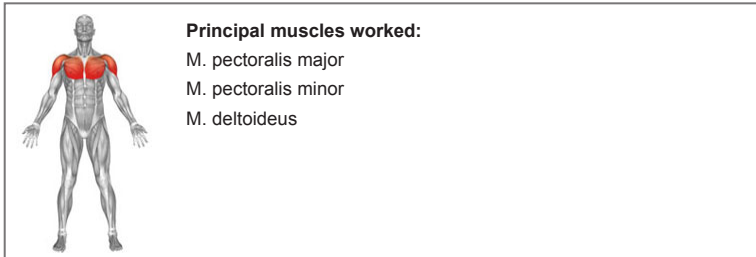

Start position



End position



1. Adopt the right exercise position: Sit on the seat so that your upper body touches the backrest completely. Place your feet about shoulder width apart. Grasp the handlebars with your hands at shoulder height. Your palms are facing forwards. Your arms should be almost completely extended (also see Chapter 5.4).
2. Now contract your torso muscles, and push your arms together in front of your upper body against the resistance of the machine. Breathe out when you exert strain against the resistance.
3. Now return the handholds to the start position, making sure to maintain control. Stop the return motion when the upper arms are in line with the axis of your shoulders. Breathe in during the return sequence.

Exercise variations: Vary the angle between your arm and torso (adjust the height of the handlebars) to work different areas of the chest muscles individually. When choosing an angle of 90°, the middle part of the chest muscles will be targeted with increased intensity, while an angle exceeding 90° (arm extended diagonal and upwards) focuses on the upper muscle area. An angle of less than 90° (arm extended downwards) increases the stress on the lower part.

8.5.3.2 CHEST PRESS 4000

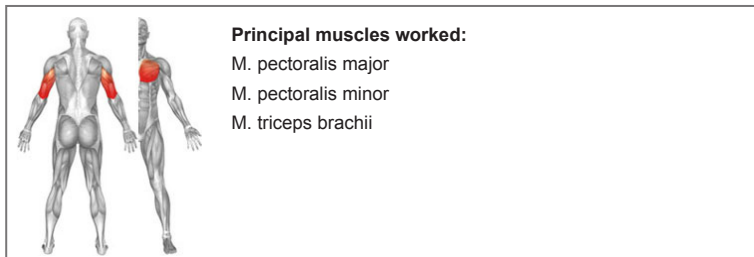

Start position



End position



1. Adopt the right exercise position: Sit on the seat so that your upper body touches the backrest completely. Place your feet about shoulder width apart. Kick down the easy entry feature to move the handles forwards. Grasp the handlebars with your hands. Your palms are facing downwards. Bend your elbows at a right angle. Your arms are at shoulder height (also see Chapter 5.4).
2. Now contract your torso muscles, extend your arms forwards against the resistance of the machine until your elbows are almost completely extended. Make sure not to hyperextend your elbows. This may lead to injuries and arthrosis in the long term. Breathe out when you exert strain against the resistance. Maintain this position momentarily.
3. Now bend your elbows and return the handles, making sure to maintain control. Stop the return motion when the upper arms are in line with the axis of your shoulders. Breathe in during the return sequence. When you have finished the training sequence, kick the easy entry feature again with your foot. Now release the handles and return them to the start position.

Exercise variations:

- ⊗ Choose a different handlebar position so that your palms are facing each other. Continue the exercise exactly as described above. With this variation, you can increase the effect on the triceps brachii
- ⊗ Vary the angle between your arm and torso (modify the height of the seat) to work different areas of the chest muscles individually. When choosing an angle of 90°, the middle part of the chest muscles will be targeted with increased intensity, while an angle exceeding 90° (arm extended diagonally and upwards) focuses on the upper muscle area. An angle of less than 90° (arm extended downwards) increases the stress on the lower part.

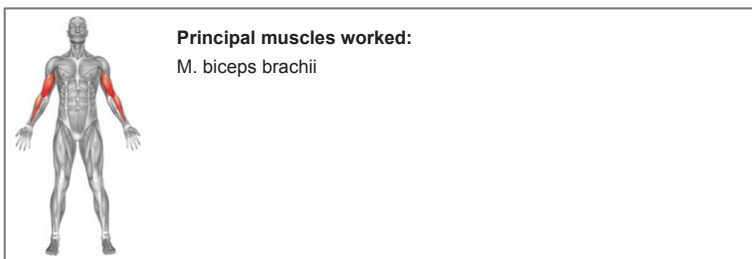
8.5.4 Upper arm muscles**8.5.4.1 BICEPS FLEXION 4000****Start position****End position**

1. Adopt the right exercise position: Sit on the seat so that your upper body touches the chest pad. Place your feet about shoulder width apart. Rest your hands on the arm pads and grasp the handlebars with your hands. Your palms are facing

upwards. Your elbows should be at the height of the machine's rotation axis and almost completely extended (also see Chapter 5.4).

2. Now contract your torso muscles, and bend your arms against the resistance of the machine. Lift your forearms upwards in a semicircular curve. The motion originates from the elbows only and should stop when your forearms reach the vertical line. Breathe out when you exert strain against the resistance. Maintain this position momentarily
3. Now straighten your arms and return the handles, making sure to maintain control. Stop the return motion when your arms are almost completely extended. Make sure not to hyperextend your elbow joints as this increases the stress on your elbows. Breathe in during the return sequence.

8.5.4.2 TRICEPS EXTENSION 4000

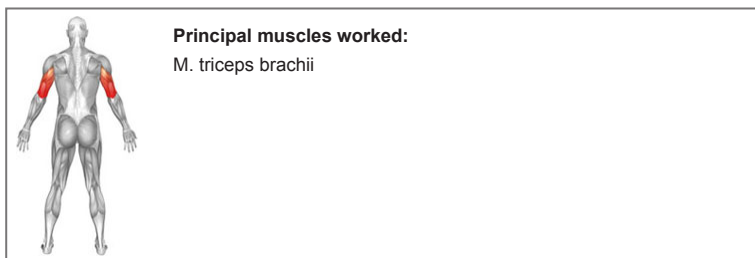

Start position



End position



1. Adopt the right exercise position: Sit on the seat so that your upper body touches the back pad. Place your feet about shoulder width apart. Rest your upper arms on the arm pads. Grasp the handlebars with your hands. Your palms are facing each other. Your elbows should be at the height of the machine's rotation axis and your

- forearms should be vertical (also see Chapter 5.4).
2. Now contract your torso muscles, and stretch your arms against the resistance of the machine. Move your forearms downwards in a semicircular curve. The motion originates from the elbow joints only and should stop when your forearms are extended. Make sure not to hyperextend your elbow joints as this increases the stress on your elbows. Breathe out when you exert strain against the resistance. Maintain this position momentarily.
 3. Now bend your elbows and return the handles, making sure to maintain control. Stop the return motion once your forearms are vertical. Breathe in during the return sequence.

8.5.5 Abdominal muscles

8.5.5.1 ABDOMINAL FLEXION 4000

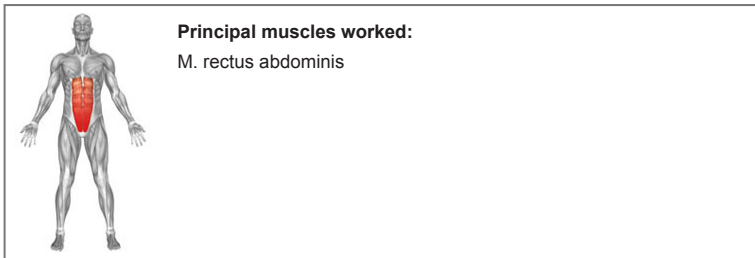

Start position



End position



1. Adopt the right exercise position: Sit on the seat so that the upper part of your chest touches the chest pad. Place the balls of your feet on the footrests (feet about shoulder width apart). Hug the chest pad with your arms (also see Chapter 5.4).

2. Lower your upper body against the resistance of the pad until it reaches an angle of approx. 45°. Breathe out when you exert strain against the resistance. Maintain this position momentarily.
3. Now lift your upper body back up, making sure to maintain control. Stop the return motion once you are sitting upright. Make sure not to hyperextend your upper body. Breathe in during the return sequence.

8.5.5.2 ABDOMINAL TORSION 4000

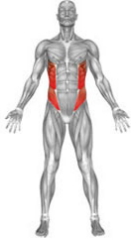

Principal muscles worked:
 M. obliquus internus abdominis
 M. obliquus externus abdominis

Start position



End position



1. Adopt the right exercise position: Sit on the seat and set the training direction by pulling the adjustment lever close to the right handle. Turn your upper body to the right. Position your legs to the right and left of the leg pads and place your feet about shoulder width apart. Wrap your arms around the handles. Place your forearms on the forearm restraints (also see Chapter 5.4).
2. Contract your lateral abdominal muscles and turn your upper body to the left against the resistance of the pad. Breathe out when you exert strain against the resistance. Maintain this position momentarily.

- Return your upper body to the start position. Breathe in during the return sequence.

Exercise variations: Move the adjustment lever while you are sitting and turn your upper body to the left. Continue the exercise as described above but turn your upper body to the right.

8.5.6 Pelvic muscles

8.5.6.1 ABDUCTOR 4000

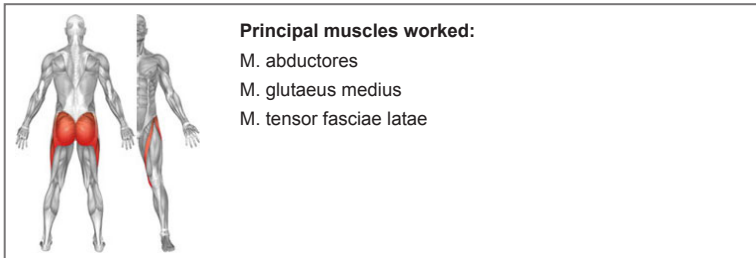

Start position



End position



- Adopt the right exercise position: Sit on the seat so that your upper body touches the backrest completely. Place the balls of your feet on the footrests and rest your knees against the knee pads. Hold the lateral handlebars with your hands (also see Chapter 5.4).
- Open your legs against the resistance of the machine as far as you can. Breathe out when you exert strain against the resistance. Maintain this position momentarily.

3. Return to the start position by closing your legs. Stop the return motion before your knees touch. Breathe in during the return sequence.

8.5.6.2 ADDUCTOR 4000

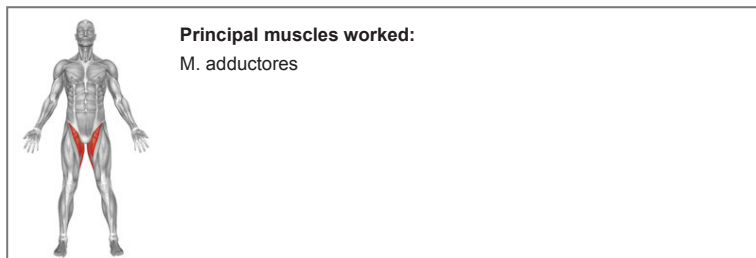

Start position



End position



1. Adopt the right exercise position: Sit on the seat so that your upper body touches the backrest completely. Place the balls of your feet on the footrests and rest your knees against the kneepads. Hold the lateral handlebars with your hands (also see Chapter 5.4).
2. Close your legs against the resistance of the machine until the pads almost touch each other. Breathe out when you exert strain against the resistance. Maintain this position momentarily.
3. Return to the start position by closing your legs. Stop the return motion when your legs are opened as wide as possible. Breathe in during the return sequence.

8.5.6.3 HIP EXTENSION 4000

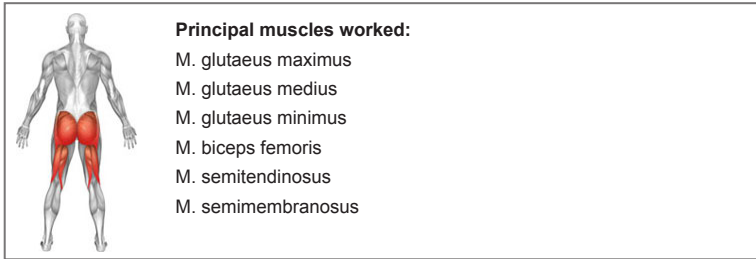

Start position



End position



1. Adopt the right exercise position: Stand next to the machine and rest your upper body against the upper body restraint. Hold the handlebars with both hands. Place your left foot firmly on the ground and the ball of your right foot on the footrest (also see Chapter 5.4).
2. Extend your right leg back and upwards against the resistance of the machine until your hip is extended. Breathe out when you exert strain against the resistance. Maintain this position momentarily.
3. Return your leg to the start position. Stop the return motion when your thigh is vertical. Breathe in during the return sequence.

Exercise variations: Place your right foot on the ground and your left foot on the footrest. Continue the exercise as described above with the other leg.

8.5.7 Thigh muscles

8.5.7.1 LEG EXTENSION 4000

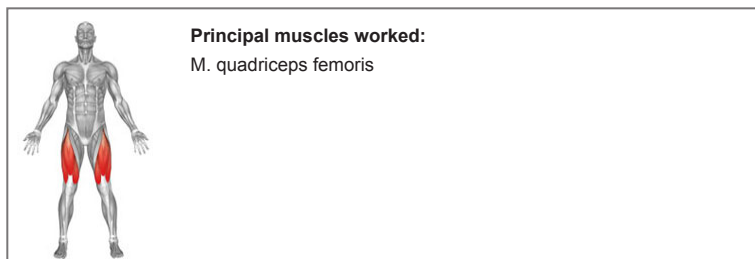

Start position



End position



1. Adopt the right exercise position: Sit on the seat so that your upper body touches the backrest completely. The axis of your knee joint should be at the same height as the rotation axis of the machine. Position your feet behind the foot padding so that the pad is in the same height as your ankle joint. Hold the handlebars with both hands (also see Chapter 5.4).
2. Extend your legs upwards in front of you until your knees are almost completely straight. Make sure that the motion originates in the knee joint only and that your knees are not hyperextended. Breathe out when you exert strain against the resistance. Maintain this position momentarily.
3. Now return your legs to the start position. Stop the return motion once your knee joints reach an angle of approx. 90°. Breathe in during the return sequence.

Exercise variations: You can also perform this exercise with only one leg. This prevents the stronger leg from performing more of the work.

8.5.7.2 LEG FLEXION 4000

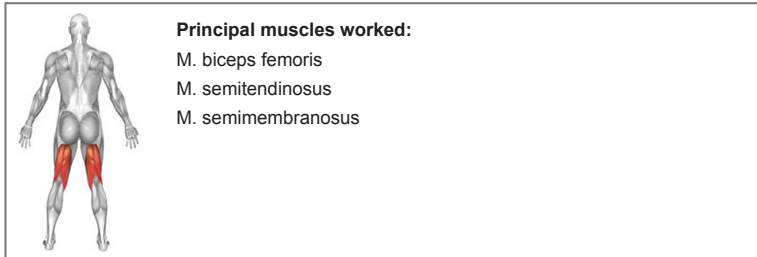

Start position



End position



1. Adopt the right exercise position: Sit on the seat so that your upper body touches the backrest completely. The axis of your knee joint should be at the same height as the rotation axis of the machine. Place your feet in front of the foot padding so that the pad is at the same height as your ankle joint. Secure your legs with the thigh restraint and hold the handlebars with both hands (also see Chapter 5.4).
2. Bend your legs back and upwards until your knees reach an angle of approx. 90°. Breathe out when you exert strain against the resistance. Maintain this position momentarily.
3. Now extend your legs to the start position. Stop the return motion when your knees are almost completely straight. Make sure that the motion originates from the knee joint only and that your knees are not hyperextended. Breathe in during the return sequence.

Exercise variations: You can also perform this exercise with only one leg. This prevents the stronger leg from performing more of the work.

8.5.7.3 SQUAT PRESS 4000

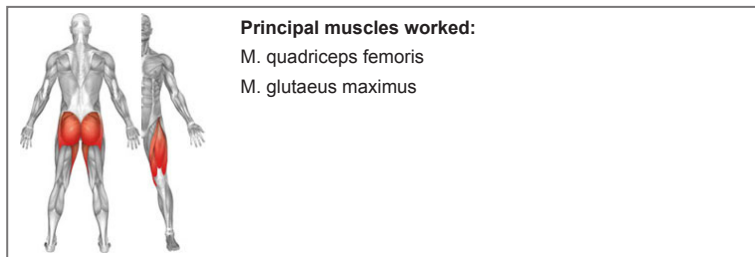

Start position



End position



1. Adopt the right exercise position: Sit on the seat so that your upper body touches the backrest completely. Make sure to adjust the backrest's slope ergonomically to counteract existing back pain. For recumbent workouts position the seat as far forward as possible and the shoulder rests as far down as possible in order to best use the swing. Place your feet on the footrests about shoulder width apart. The height of your feet on the footrest is determined by your legs, which should be bent at an angle of approx. 90°. If you have knee problems, this angle should not be less than 90°.
2. Extend your legs against the resistance of the machine until your knees are almost completely straight. Make sure not to hyperextend your knees! Breathe out when you exert strain against the resistance. Maintain this position momentarily.
3. Bend your legs to return to the start position. Stop the return motion once the legs reach an angle of approx. 90°. Breathe in during the return sequence.

Exercise variations:

- ⊗ You can also perform this exercise with only one leg. This prevents the stronger leg from performing more of the work..

- ⊗ Vary the position of your feet to target different muscle groups individually:
 - a) Feet at the upper edge of the footrest (optimal positioning of the feet in case of knee problems): The muscle work is mainly taken over by the gluteal muscles (M. gluteus maximus) as well as the muscles on the rear of the thighs M. biceps femoris, M. semitendinosus, M. semimembranosus)
 - b) Feet on the lower edge of the footrest: The muscle work is mainly taken over by the front muscles on the thighs (M. quadriceps femoris).
 - c) Feet largely apart: The muscle work is mainly taken over by the lateral inside muscles of the thighs (Mm. adductores).
 - d) Feet closely together: The muscle work is mainly taken over by the lateral front muscles of the thighs (M. quadriceps femoris).

- ⊗ The SQUAT PRESS 4000 can still be used with accessory tools (e.g. sensomotor tools). Please proceed as follows: Move the seat to the rear end position of the guide rail. Put the footrest (see chapter 5.6.7.3 „components“) in position 3 (vertical) and sit down on the machine.

Place one foot on the footrest below the accessory tool and press against the resistance until the knee is only bent slightly. Then repeat this exercise with the other foot. After you reached a stable position put both feet on the accessory tool and start the workout.

Stop the workout in reversed order, i.e. put one foot after the other on the footrest and move the seat to the starting position.

- ⊗ When using the Togu Aero-Step:

Please always observe the operating and maintenance instructions provided by Togu, especially the max. weight load of 200 kg and the permanent check/regulation of the vertical load, so that the Aero-Step always rests flat on the ground.

When using the Aero-Step on the footrest of the Squat Press 4000, both feet should be placed on the cushion and the weight should be pushed away evenly at a moderate speed. We recommend the max. weight of 150 kg (weight plate 20), so that the max. weight load of the Aero-Step of 200 kg is not exceeded.

Please completely refrain from jumps or quick thrusts, even when adjusting at a low weight.

8.5.8 Multifunctional

8.5.8.1 PULL UP/DIP 4000

8.5.8.1.1 PULL UP 4000

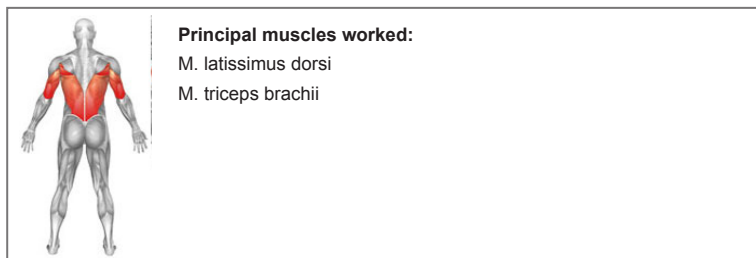

Start position

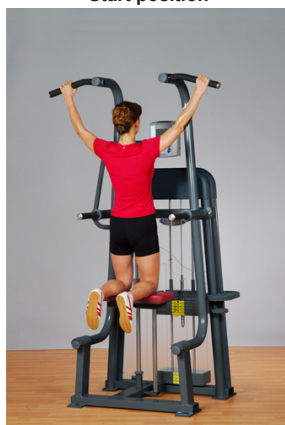

End position

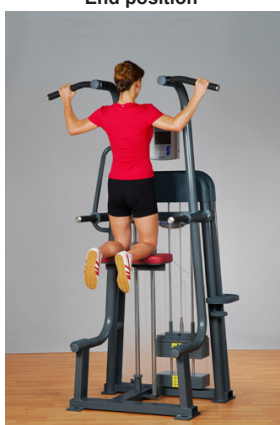

1. Adopt the right exercise position: Kneel on the pad while facing the machine. Your legs should be about shoulder width apart and parallel to each other. Grasp the upper outer handlebars with your hands. Your palms are facing forwards and your arms are almost fully extended (also see Chapter 5.4).
2. Lift yourself up slowly. Avoid any rotation of your elbow joints. Breathe out when you exert strain against the resistance. Maintain this position momentarily.
3. Let yourself sink until your arms are almost completely straight. Make sure not to hyperextend your elbow joints. Breathe in during the return sequence.

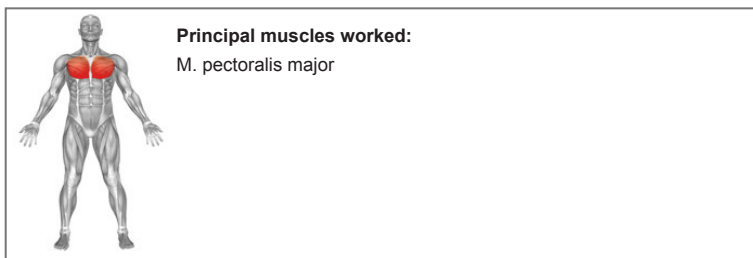
8.5.8.1.2 DIP 4000**Start position****End position**

1. Adopt the right exercise position: Kneel on the pad while facing the machine. Your legs should be about shoulder width apart and parallel to each other. Grasp the outer handlebars with your hands. Your palms are facing your body and your arms are almost completely extended (also see Chapter 5.4).
2. Let yourself sink until the handlebars are almost at the height of your chest and your upper arms in a horizontal position. Breathe in during this motion. Maintain this position momentarily.
3. Now contract your arm and chest muscles, and slowly lift yourself upwards until your arms are almost completely straight. Make sure not to hyperextend your elbow joints. Breathe out when you exert strain against the resistance.

8.5.8.2 SEATED DIP 4000

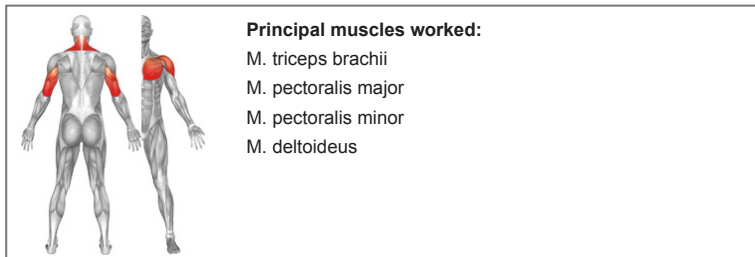

Start position



End position



1. Adopt the right exercise position: Sit on the seat so that your upper body touches the backrest completely. Your legs should be about shoulder width apart and parallel to each other. Grasp the outer handlebars with your hands. Your palms are facing your body. Bend your elbows at a right angle., your arms are approximately on the height of your shoulders.
2. Now contract your torso muscles, and stretch your arms against the resistance of the machine, the motion should stop when your forearms are extended. Make sure not to hyperextend your elbow joints as this increases the stress on your elbows. Breathe out when you exert strain against the resistance. Maintain this position momentarily.
3. Now bend your elbows and return the handles, making sure to maintain control. Stop the return motion once your arms reach the height of your shoulders. Breathe in during the return sequence.

Chapter 9 Maintenance

9.1	Care and maintenance	82
9.2	Cleaning	83

Please note:

This owner's manual contains information on multiple gym machines.
There may be variations in detail according to the type of machine!

9 Maintenance

Regular, thorough care and appropriate maintenance in particular help preserve the value and extend the lifetime of your exercise machine. For this reason, we recommend regular preventive maintenance! Always switch off the machine for maintenance and cleaning!

These regular inspections are essential for compliance in case of guarantee claims. In case of a malfunction, ERGO-FIT's technicians and engineers are pleased to assist you.

Immediate maintenance is to be carried out if:

- ⊗ the machine has undergone extreme mechanical stress
- ⊗ steel cables, Kevlar cables, rollers, handles, levers or snap-on weights are damaged

Maintenance of the machine may be carried out by ERGO-FIT's customer service department. A maintenance contract may also be implemented.

9.1 Care and maintenance

During manufacturing of its training machines, ERGO-FIT makes every effort to reduce future maintenance.

In the following chapters, some of the maintenance and inspection tasks are described. You should carry out these tasks regularly.

During maintenance, consider the following:

- ⊗ This machine requires very little maintenance.
- ⊗ Moving parts need no further oiling or greasing.
- ⊗ The chrome bars need to be cleaned with a dry cloth and sprayed with teflon spray.
- ⊗ Before every use, check paddings, frame, steel cables, Kevlar cables, snap-on weights, handles and levers for cracks or breaks.
- ⊗ Before every use, check if all fastenings are firmly tightened.
- ⊗ Regularly check the correct position of the sensor connectors on 4000 S machines.
- ⊗ Please lubricate the non-coated ropes monthly or as required. We recommend „Spray AT44 Allround Spray mit Teflon“.

9.2 Cleaning

Sweat, dust particles and dirt will damage your exercise machine. This can be observed after only a few weeks. Metal and aluminium parts of your machine may alter its surfaces in combination with sweat. For this reason, you should clean your machine every day.

We recommend “Ecolab P3-steril” or “Scarabig” for cleaning. You can obtain these detergents at the following suppliers:

Ecolab Deutschland GmbH
Reisholzer Werftstraße 38-42
Postfach 13 04 06
D-40554 Düsseldorf
www.ecolab.com

SCARAPHARM chem.-pharm. Produkte GmbH
Wachmannstraße 86
D-28209 Bremen
www.scarapharm.de

During cleaning, consider the following aspects:

Note that the power cord is unplugged when opening the cockpit!

- ⊗ Clean your machine with a damp cloth, mild cleaning agent or soap suds only and dry it with a soft cloth.
- ⊗ Regularly clean the lens and the display of the 4000 S sensor.

During training with chip card regularly clean the chip cards and chip-card readers with a cloth and isopropanol. Special cleaning sets are also available with ERGO-FIT GmbH & Co. KG.

Chapter 10 Troubleshooting

10.1	Finding the Error	86
10.2	Error Messages	87

Please note:

This owner's manual contains information on multiple gym machines.
There may be variations in detail according to the type of machine!

10 Troubleshooting

Despite the high quality of ERGO-FIT products malfunctions may occur. In this chapter you find troubleshooting information. If you suspect a technical malfunction do not operate the machine. If you can repair the machine yourself nevertheless inform us of the malfunction. This allows us to record the failure in the model's documentation file and to further improve the quality of our products.

For safety reasons, unplug the machine before work is carried out or the machine is opened!



10.1 Finding the Error

Malfunctions may have simple reasons but sometimes a faulty component is the problem. This chapter provides you with guidelines to resolve possible problems. If the recommendations listed are not successful, please contact our service department immediately. Our service team will be pleased to help you.

Please proceed as follows in case of failure:

The panel pc does not react

- ⊗ Check the fuse box. A fuse may be defective or a circuit breaker may have switched off.
- ⊗ Did you use an extension cable or a multi-outlet power strip? Always connect your machine directly to the power socket.
- ⊗ Check the power socket. Plug in another electric device to check the socket.
- ⊗ Pull the power plug out of the socket and visually inspect the power supply cord.

An error message is displayed

- ⊗ Write down the information displayed in the error message.
- ⊗ Check if the error has occurred frequently. If so, when and how often?
- ⊗ If you were not present when the error message was displayed, ask the user what exactly happened.
- ⊗ Try to fix the error yourself (see: error messages) or contact the ERGO-FIT service center.

10.2 Error Messages

The following section lists the most common error messages, their causes and solutions.

Message: Unknown card

Problem: There is no data on the chip card - the chip card has possibly never been used, or the chip itself is damaged.

Solution: Reinitialize the card. If the issue is not solved, please use a new chip card and restart the initialization.

Message: Please login at the Vitality Coach

Problem: No workout data stored on the chip card.

Solution: The workout has not been activated at the Vitality Coach, thus there is no workout data on the chip card. Return to the Vitality Coach and insert the chip card. Press the "START" button to save data on the chip card.

Message: Communication with board lost.

Problem: No connection to device board. Training is not possible.

Solution: Please contact the ERGO-FIT service center.

Message: Unknown error

Problem: An unknown error occurred that cannot automatically be solved.

Solution: Please contact the ERGO-FIT service center.

Chapter A Appendix

A.1	Customer service	90
A.2	Ordering information	90
A.3	Technical specifications	90
A.3.1	Back muscles	91
A.3.2	Shoulder muscles	92
A.3.3	Chest muscles	92
A.3.4	Upper arm muscles	93
A.3.5	Abdominal muscles	93
A.3.6	Pelvic muscles	94
A.3.7	Thigh muscles	95
A.3.8	Multifunctional	96
A.3.9	Benches	98
A.4	Warranty clauses	101
A.5	Safety Information	103

Please note:

This owner's manual contains information on multiple gym machines.
There may be variations in detail according to the type of machine!

A Appendix

A.1 Customer service

If you cannot correct a malfunction yourself, please get in touch with our customer service.

Service: Phone: +49 (6331) 2461-20 international
+49 (6331) 2461-45 international
+49 (6331) 2461-23 national
+49 (6331) 2461-27 national
+49 (6331) 2461-29 national
Telefax: +49 (6331) 2461-55
E-Mail: service@ergo-fit.de

Repairs of ERGO-FIT machines are carried out by highly qualified and competent service technicians. Only original spare parts are used for repairs.

A.2 Ersatzteile

Ersatzteile sowie aktuelle Explosionszeichnungen können bei Bedarf bei der Serviceabteilung der Firma ERGO-FIT angefordert werden:

Service: Phone: +49 (6331) 2461-20 international
+49 (6331) 2461-45 international
+49 (6331) 2461-23 national
+49 (6331) 2461-27 national
+49 (6331) 2461-29 national
Telefax: +49 (6331) 2461-55
E-Mail: ersatzteile@ergo-fit.de

When ordering, please provide the following information:

- ⊗ model
- ⊗ serial number

A.3 Technical specifications

This chapter provides the technical specifications of your strength exercise machine. The specifications are listed in separate charts for each model of the POWER LINE 4000 series and sorted by muscle groups..

A.3.1 Back muscles

	BACK EXTENSION 4000	BACK PULL 4000
Area of application	Fitness / medical	Fitness / medical
Dimensions in cm (L/W/H)	100 x 120 x 155	120 x 145 x 155
Max. weight mounting / Weight plate increment	100 kg / 5kg	75 kg / 5kg
Total weight /machine	approx. 235 kg	approx. 205 kg
Max. weight strain	200 kg	200 kg
Adjustments possible	Lever arm	Seat height, Chest pad
Adjustment by pneumatic spring	-	Seat height adjustment
Eccentric	yes	o
Locked dowel pins	yes	yes
Easy entry feature	no	yes
Weight transmission	Steel cable	Steel cable
Ambient temperature: Operation Ambient temperature: Storage	+10°C to +40°C -30°C to +50°C	+10°C to +40°C -30°C to +50°C
Relative humidity	30% to 75% non condensing	30% to 75% non condensing

	BUTTERFLY REVERSE 4000	LAT PULL 4000
Area of application	Fitness / medical	Fitness / medical
Dimensions in cm (L/W/H)	135 x 155 x 155	130 x 170 x 240
Max. weight mounting / Weight plate increment	60 kg / 5kg	75 kg / 5kg
Total weight /machine	approx. 190 kg	approx. 220 kg
Max. weight strain	200 kg	200 kg
Adjustments possible	Seat height	Seat height, thigh restraint
Adjustment by pneumatic spring	Seat height adjustment	Seat height adjustment
Eccentric	yes	no
Locked dowel pins	yes	yes
Easy entry feature	no	no
Weight transmission	Steel cable	Steel cable
Ambient temperature: Operation Ambient temperature: Storage	+10°C to +40°C -30°C to +50°C	+10°C to +40°C -30°C to +50°C
Relative humidity	30% to 75% non condensing	30% to 75% non condensing

A.3.2 Shoulder muscles

	SHOULDER ABDUCTION 4000	SHOULDER PRESS 4000
Area of application	Fitness / medical	Fitness / medical
Dimensions in cm (L/W/H)	120 x 115 x 155	135 x 135 x 180
Max. weight mounting / Weight plate increment	75 kg / 5kg	75 kg / 5kg
Total weight /machine	approx. 200 kg	approx. 210 kg
Max. weight strain	200 kg	200 kg
Adjustments possible	Seat height	Seat height
Adjustment by pneumatic spring	Seat height adjustment	Seat height adjustment
Eccentric	no	no
Locked dowel pins	yes	yes
Easy entry feature	no	no
Weight transmission	Steel cable	Steel cable
Ambient temperature: Operation Ambient temperature: Storage	+10°C to +40°C -30°C to +50°C	+10°C to +40°C -30°C to +50°C
Relative humidity	30% to 75% non condensing	30% to 75% non condensing

A.3.3 Chest muscles

	BUTTERFLY 4000	CHEST PRESS 4000
Area of application	Fitness / medical	Fitness / medical
Dimensions in cm (L/W/H)	120 x 155 x 155	145 x 155 x 155
Max. weight mounting / Weight plate increment	75 kg / 5kg	75 kg / 5kg
Total weight /machine	approx. 200 kg	approx. 230 kg
Max. weight strain	200 kg	200 kg
Adjustments possible	Lever arm	Seat height
Adjustment by pneumatic spring	-	Seat height adjustment
Eccentric	yes	no
Locked dowel pins	yes	yes
Easy entry feature	no	yes
Weight transmission	Steel cable	Steel cable
Ambient temperature: Operation Ambient temperature: Storage	+10°C to +40°C -30°C to +50°C	+10°C to +40°C -30°C to +50°C
Relative humidity	30% to 75% non condensing	30% to 75% non condensing

A.3.4 Upper arm muscles

	BICEPS FLEXION 4000	TRICEPS EXTENSION 4000
Area of application	Fitness / medical	Fitness / medical
Dimensions in cm (L/W/H)	95 x 130 x 155	135 x 110 x 180
Max. weight mounting / Weight plate increment	60 kg / 5kg	60 kg / 5kg
Total weight /machine	approx. 170 kg	approx. 185 kg
Max. weight strain	200 kg	200 kg
Adjustments possible	Seat height, lever arm	Seat height, lever arm, Back padding
Adjustment by pneumatic spring	Seat height adjustment	Seat height adjustment
Eccentric	yes	no
Locked dowel pins	yes	yes
Easy entry feature	no	no
Weight transmission	Steel cable	Steel cable
Ambient temperature: Operation Ambient temperature: Storage	+10°C to +40°C -30°C to +50°C	+10°C to +40°C -30°C to +50°C
Relative humidity	30% to 75% non condensing	30% to 75% non condensing

A.3.5 Abdominal muscles

	ABDOMINAL FLEXION 4000	ABDOMINAL TORSION 4000
Area of application	Fitness / medical	Fitness / medical
Dimensions in cm (L/W/H)	105 x 130 x 155	135 x 100 x 155
Max. weight mounting / Weight plate increment	75 kg / 5kg	60 kg / 5kg
Total weight /machine	approx. 220 kg	approx. 170 kg
Max. weight strain	200 kg	200 kg
Adjustments possible	Lever arm	-
Adjustment by pneumatic spring	-	-
Eccentric	yes	no
Locked dowel pins	yes	yes
Easy entry feature	no	no
Weight transmission	Steel cable	Steel cable
Ambient temperature: Operation Ambient temperature: Storage	+10°C to +40°C -30°C to +50°C	+10°C to +40°C -30°C to +50°C
Relative humidity	30% to 75% non condensing	30% to 75% non condensing

A.3.6 Pelvic muscles

	ABDUCTOR 4000	ADDUCTOR 4000
Area of application	Fitness / medical	Fitness / medical
Dimensions in cm (L/W/H)	140 x 130 x 155	175 x 125 x 155
Max. weight mounting / Weight plate increment	75 kg / 5kg	75 kg / 5kg
Total weight /machine	approx. 215 kg	approx. 215 kg
Max. weight strain	200 kg	200 kg
Adjustments possible	angle of spread	angle of spread
Adjustment by pneumatic spring	-	-
Eccentric	yes	yes
Locked dowel pins	yes	yes
Easy entry feature	no	no
Weight transmission	Steel cable	Steel cable
Ambient temperature: Operation Ambient temperature: Storage	+10°C to +40°C -30°C to +50°C	+10°C to +40°C -30°C to +50°C
Relative humidity	30% to 75% non condensing	30% to 75% non condensing

	HIP EXTENSION 4000
Area of application	Fitness / medical
Dimensions in cm (L/W/H)	100 x 125 x 155
Max. weight mounting / Weight plate increment	60 kg / 5kg
Total weight /machine	approx. 170 kg
Max. weight strain	200 kg
Adjustments possible	-
Adjustment by pneumatic spring	-
Eccentric	yes
Locked dowel pins	yes
Easy entry feature	no
Weight transmission	Steel cable
Ambient temperature: Operation Ambient temperature: Storage	+10°C to +40°C -30°C to +50°C
Relative humidity	30% to 75% non condensing

A.3.7 Thigh muscles

	LEG EXTENSION 4000	LEG FLEXION 4000
Area of application	Fitness / medical	Fitness / medical
Dimensions in cm (L/W/H)	105 x 140 x 155	105 x 145 x 155
Max. weight mounting / Weight plate increment	100 kg / 5kg	75 kg / 5kg
Total weight /machine	approx. 265 kg	approx. 255 kg
Max. weight strain	200 kg	200 kg
Adjustments possible	Back rest, leg length,, lever arm	Lever arm, foot pad, back rest, thigh restraint
Adjustment by pneumatic spring	-	Seat height adjustment
Eccentric	yes	yes
Locked dowel pins	yes	yes
Easy entry feature	no	no
Weight transmission	Steel cable	Steel cable
Ambient temperature: Operation Ambient temperature: Storage	+10°C to +40°C -30°C to +50°C	+10°C to +40°C -30°C to +50°C
Relative humidity	30% to 75% non condensing	30% to 75% non condensing

	SQUAT PRESS 4000
Area of application	Fitness / medical
Dimensions in cm (L/W/H)	100 x 240 x 155
Max. weight mounting / Weight plate increment	172,5 kg / 7,5kg
Total weight /machine	approx. 415 kg
Max. weight strain	200 kg
Adjustments possible	Back rest, leg length, foot rest
Adjustment by pneumatic spring	-
Eccentric	no
Locked dowel pins	yes
Easy entry feature	no
Weight transmission	Steel cable
Ambient temperature: Operation Ambient temperature: Storage	+10°C to +40°C -30°C to +50°C
Relative humidity	30% to 75% non condensing

A.3.8 Multifunctional

	CABLE 4000 Standmodel	CABLE 4000 Wandmodel
Area of application	Fitness / medical	Fitness / medical
Dimensions in cm (L/W/H)	120 x 160 x 225	86 x 41 x 225
Max. weight mounting / Weight plate increment	75 kg / 5kg	75 kg / 5kg
Total weight /machine	approx. 156 kg	approx. 123 kg
Max. weight strain	-	-
Adjustments possible	-	-
Adjustment by pneumatic spring	-	-
Eccentric	no	no
Locked dowel pins	yes	yes
Easy entry feature	no	no
Weight transmission	Kevlar cable	Kevlar cable
Ambient temperature: Operation Ambient temperature: Storage	+10°C to +40°C -30°C to +50°C	+10°C to +40°C -30°C to +50°C
Relative humidity	30% to 75% non condensing	30% to 75% non condensing

	CABLE CROSSOVER 4000	CABLE TOWER 4000
Area of application	Fitness	Fitness
Dimensions in cm (L/W/H)	91 x 338 x 218	120 x 290 x 220
Max. weight mounting / Weight plate increment	2 x 75 kg / 5kg	2 x 100 kg, 2 x 75 kg / 5kg
Total weight /machine	approx. 250 kg	approx. 530 kg
Max. weight strain	-	200 kg
Adjustments possible	-	thigh restraint
Adjustment by pneumatic spring	-	-
Eccentric	no	no
Locked dowel pins	yes	yes
Easy entry feature	no	no
Weight transmission	Steel cable	Steel cable
Ambient temperature: Operation Ambient temperature: Storage	+10°C to +40°C -30°C to +50°C	+10°C to +40°C -30°C to +50°C
Relative humidity	30% to 75% non condensing	30% to 75% non condensing

	MULTI PRESS 4000
Area of application	Fitness
Dimensions in cm (L/W/H)	170 x 210 x 220
Max. load	300 kg
Total weight /machine	approx. 150 kg
Max. weight strain	-
Adjustments possible	-
Adjustment by pneumatic spring	-
Eccentric	no
Locked dowel pins	no
Easy entry feature	no
Weight transmission	-
Ambient temperature: Operation Ambient temperature: Storage	+10°C to +40°C -30°C to +50°C
Relative humidity	30% to 75% non condensing
bore diameter weight plates	50/51mm

	SEATED DIP 4000	PULL UP/DIP 4000
Area of application	Fitness / medical	Fitness/ medical
Dimensions in cm (L/W/H)	162 x 117 x 155	81 x 120 x 215
Max. weight mounting / Weight plate increment	100 kg	90 kg / 7,5kg
Total weight /machine	approx. 210 kg	approx. 210 kg
Max. weight strain	200 kg	200 kg
Adjustments possible	Seat hight, Back pad	-
Adjustment by pneumatic spring	Seat hight adjustment	-
Eccentric	no	no
Locked dowel pins	yes	yes
Easy entry feature	no	no
Weight transmission	Steel cable	Steel cable
Ambient temperature: Operation Ambient temperature: Storage	+10°C to +40°C -30°C to +50°C	+10°C to +40°C -30°C to +50°C
Relative humidity	30% to 75% non condensing	30% to 75% non condensing

A.3.9 Benches

	ABDOMINAL BENCH 4000	BACK BENCH 4000
Area of application	Fitness	Fitness
Dimensions in cm (L/B/H)	145 x 60 x 75	135 x 80 x 75
Total weight /machine	approx. 60 kg	approx. 50 kg
Max. weight-loading (user weight + weight mounting)	250 kg	250 kg
Adjustments possible	Back pad	Leg pad
Adjustment by pneumatic spring	-	-
Ambient temperature: Operation	+10°C to +40°C	+10°C to +40°C
Ambient temperature: Storage	-30°C to +50°C	-30°C to +50°C
Relative humidity	30% to 75% non condensing	30% to 75% non condensing

	FLAT BENCH 4000	MULTI BENCH 4000
Area of application	Fitness	Fitness
Dimensions in cm (L/B/H)	105 x 60 x 40	135 x 60 x 100
Total weight /machine	approx. 25 kg	approx. 35 kg
Max. weight-loading (user weight + weight mounting)	250 kg	250 kg
Adjustments possible	-	Back pad
Adjustment by pneumatic spring	-	-
Ambient temperature: Operation	+10°C to +40°C	+10°C to +40°C
Ambient temperature: Storage	-30°C to +50°C	-30°C to +50°C
Relative humidity	30% to 75% non condensing	30% to 75% non condensing

	OLYMPIC FLAT BENCH 4000	OLYMPIC INCLINE BENCH 4000
Area of application	Fitness	Fitness
Dimensions in cm (L/B/H)	160 x 125 x 125	160 x 125 x 135
Total weight /machine	approx. 50 kg	approx. 45 kg
Max. weight-loading (user weight + weight mounting)	400 kg	350 kg
Adjustments possible	-	Seat height
Adjustment by pneumatic spring	-	-
Ambient temperature: Operation Ambient temperature: Storage	+10°C to +40°C -30°C to +50°C	+10°C to +40°C -30°C to +50°C
Relative humidity	30% to 75% non condensing	30% to 75% non condensing

	SCOTT BENCH 4000
Area of application	Fitness
Dimensions in cm (L/B/H)	160 x 125 x 125
Total weight /machine	approx. 50 kg
Max. weight-loading (user weight + weight mounting)	250 kg
Adjustments possible	Seat height
Adjustment by pneumatic spring	Seat height adjustment
Ambient temperature: Operation Ambient temperature: Storage	+10°C to +40°C -30°C to +50°C
Relative humidity	30% to 75% non condensing

	SQUAT RACK 4000
Area of application	Fitness
Dimensions in cm (L/B/H)	175 x 120 x 175
Total weight /machine	approx. 65 kg
Max. load	300 kg
Adjustments possible	-
Adjustment by pneumatic spring	-
Ambient temperature: Operation	+10°C to +40°C
Ambient temperature: Storage	-30°C to +50°C
Relative humidity	30% to 75% non condensing

A.4 Warranty clauses

2 years warranty, full warranty of 4 years on request*

The seller shall be liable, to the exclusion of other liability, for deficiencies of the delivery, of which the absence of expressly affirmed properties is part, as follows:

1. All parts that are found to be unusable or restricted in use in consequence of a circumstance dated before the transfer of risk – notably because of faulty design, bad manufacturing material or faulty workmanship - shall be repaired or replaced during a period of 24 months after delivery. The decision if the fault will be repaired or should be replaced will be at the seller's discretion. The supplier shall only be liable for deficiencies of drawings and materials delivered or chosen by the seller if he would have been able to recognise the deficiency when applying professional accuracy unless the seller notified the purchaser of the recognised deficiency immediately.
2. The purchaser's right to claim ends in all cases after 24 months after transfer of the object.
3. No guarantee shall be assumed for damage as a result of inappropriate or improper use, faulty assembly or faulty startup carried out by the purchaser or a third party, natural wear, faulty or careless handling, inappropriate equipment or exchange work material, faulty construction works, chemical, electrochemical or electric influences, except in the event that they can be traced to the fault of the seller. The purchaser will assume all risks in connection with the delivery, even in case of free freight ex-factory.
4. Initially, the seller has the right to two rectifications or replacements. Should these fail, the purchaser has the right of abatement or rescission within the scope of valid legislation. The seller will have a period of six weeks as from communicating the notice of defect for rectification.
5. Improper modifications or repairs carried out on behalf of the purchaser or a third party without prior permission of the seller will abrogate warranty claims.
6. If goods are exported, warranty will be restricted to the availability of loose spare parts ex-factory within the warranty period. Packing costs, freight charge and labour will be at the expense of the purchaser. In case the purchaser demands site repair by a technician of the factory or another service address, the purchaser will assume the costs of travelling expenses and labour.
7. All merchandise that has not been produced by the seller is subject to legal provisions.

* see General Terms of Sales and Delivery

Wear parts are excluded from warranty specifications, e.g.:

- ⊗ Flat belt, steel cable, pull ropes
- ⊗ Snap-on weights
- ⊗ Dowel pins
- ⊗ Adjusting Lever
- ⊗ Paddings
- ⊗ Cable-winch sensor
- ⊗ Seat, tread, handholds

The warranty is voided if maintenance instructions are not observed!

Safety Information POWER LINE 4000

- ⊗ Do not start the machine before carefully reading this owner's manual.
- ⊗ Only use the machine after performing a proper function test.
- ⊗ Before starting the exercise please check the power supply cord (POWER LINE model „S“ only).
- ⊗ Wear only appropriate sportswear and footwear during training.
- ⊗ The machine may be used after instruction of a supervisor only. The machine must not be used without the presence of a supervisor.
- ⊗ Never start training with the maximum strain. Increase its intensity slowly.
- ⊗ Check if the rests are secured before getting on the machine.
- ⊗ Never lean on the panel pc and do not make inappropriate movements.
- ⊗ Never leave children unattended with the machine.
- ⊗ Make sure that persons who stand close to the machine are not hit by moving parts.
- ⊗ In case of nausea, dizziness, pain in the chest, limbs or joints, stop training immediately and see a doctor.
- ⊗ If you have a cardiac pacemaker, orthopaedic disabilities or a health condition, see your doctor before using the training machine.
- ⊗ When adjusting rests or restraints, please make sure to retighten them properly.
- ⊗ Do not put your hands between the snap-on weights. Make sure that the dowel pins are inserted completely into the borings and are not jammed.
- ⊗ Check the machine for damaged moving parts and paddings regularly (once per week). If the machine is damaged, have it repaired immediately.
- ⊗ Do not hold your breath during training. Breathe out during the strain sequence and breathe in during the relaxing sequence.
- ⊗ Start new power training exercises with a low strain. If you set the strain too high in the beginning, you might get injured.
- ⊗ Note that physical fatigue reduces coordination and increases the risk of injury.
- ⊗ Before training, check if all handling parts are locked properly or damaged.
- ⊗ Switch off the machine after the workout and disconnect it (POWER LINE model „S“ only).
- ⊗ Only use the machine for the purposes it is designed for.
- ⊗ Please consider further safety and operational notices in this manual.

All safety instructions in this manual are based on many years of experience and selfconception.

These safety precautions must be displayed where they are visible from the strength exercise machine! All users of the machine must be informed of the dangers and safety regulations. The manufacturer will not be liable for personal injury or material damage.



ERGO-FIT GmbH & Co. KG

Blocksbergstraße 165 – 66955 Pirmasens
Phone: (+49) 6331 2461-0 – Fax: (+49) 6331 2461-55
info@ergo-fit.de – www.ergo-fit.de